

Shallow bowl 1a

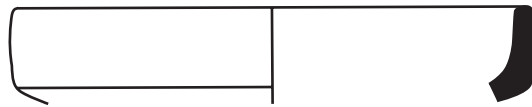

Shallow bowl 1b



Shallow bowl 2



Shallow bowl 3

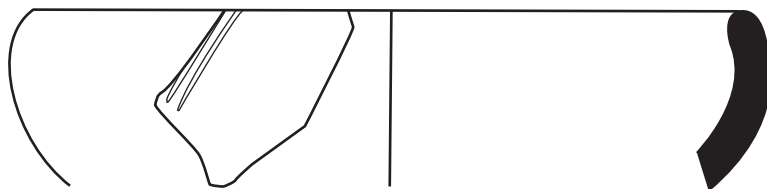

Shallow bowl 4

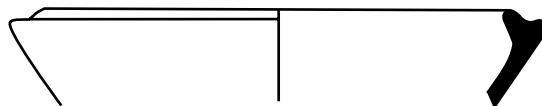

Shallow bowl 5

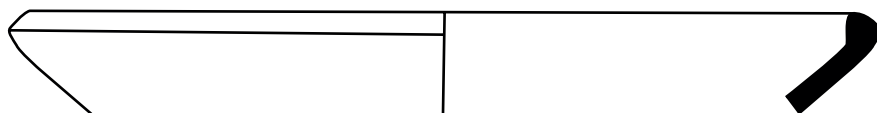

Shallow bowl 6a

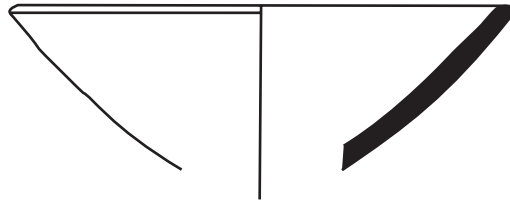

Shallow bowl 7

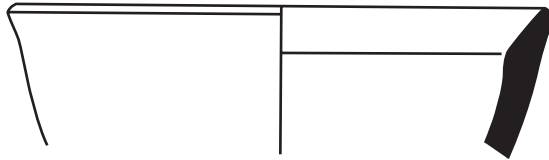

Shallow bowl 9

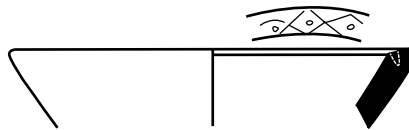

Shallow bowl 9a

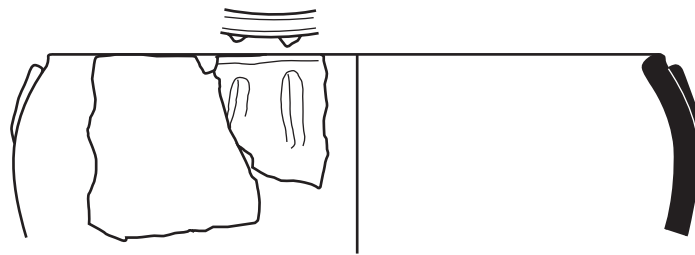

Deep bowl 4

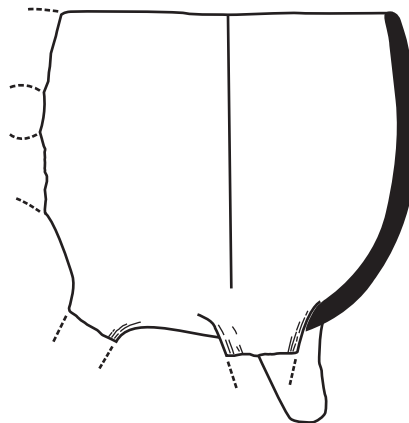

Jar 1



Neck-jar 3

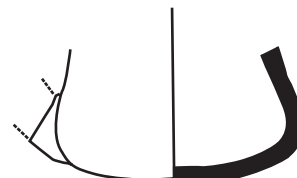

Depas

Selected EBA vessel shapes of Madra River Delta (not to scale)

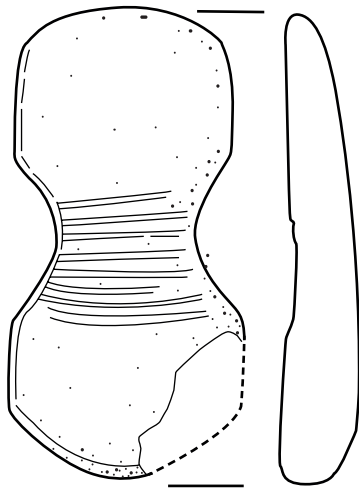

YYT-TOPSOIL-1

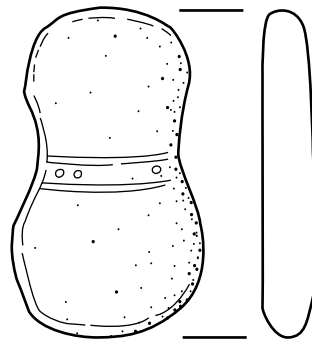

YYT-1-073-2

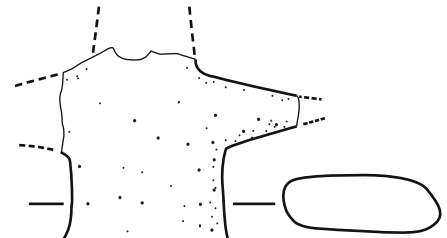

YYT-TOPSOIL-2

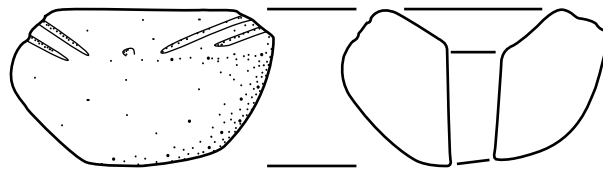
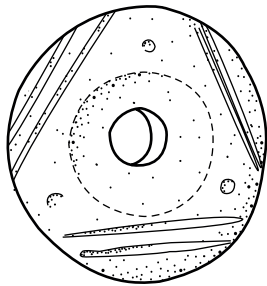

YYT-1-025-1

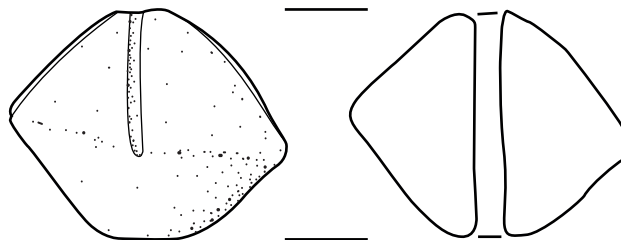
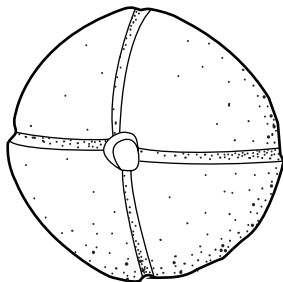

YYT-2-005-1

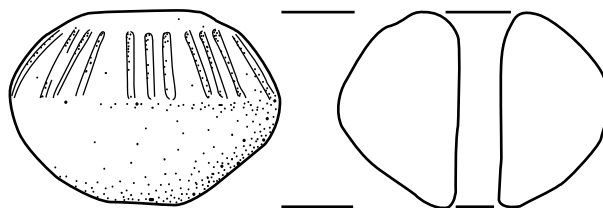
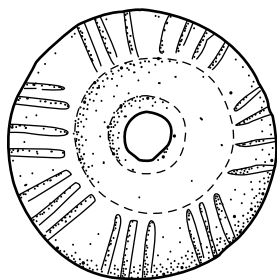

YYT-3-009-1

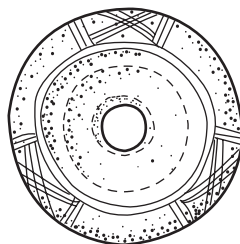

10YT-96-81

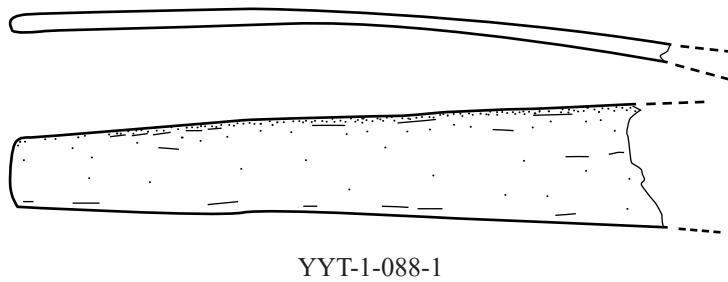
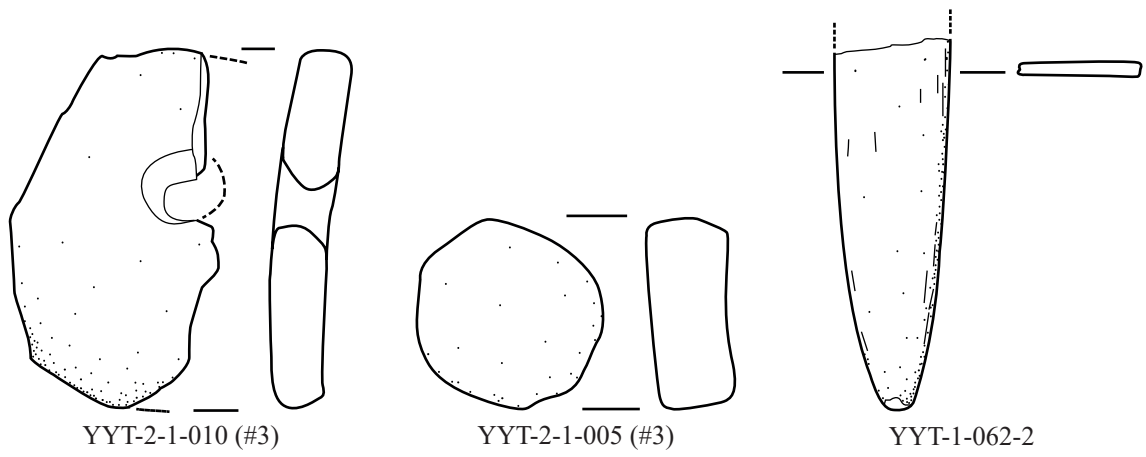
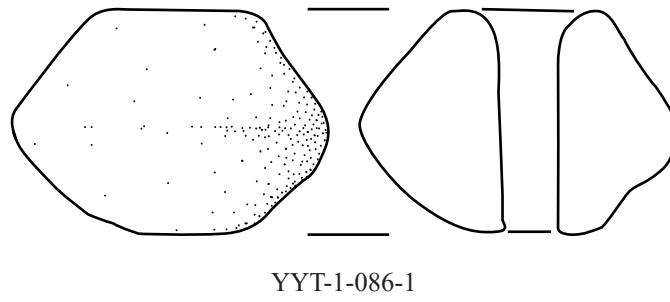
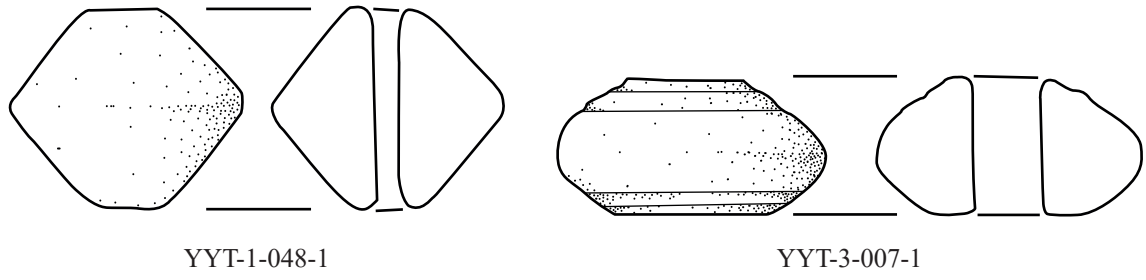
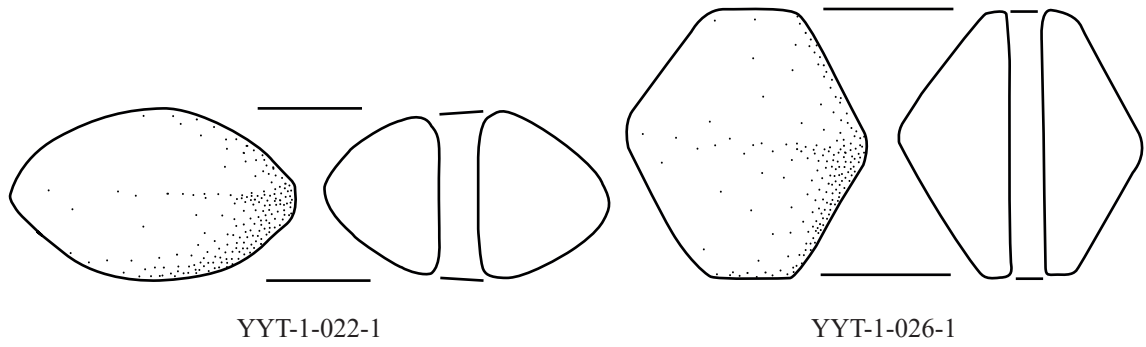



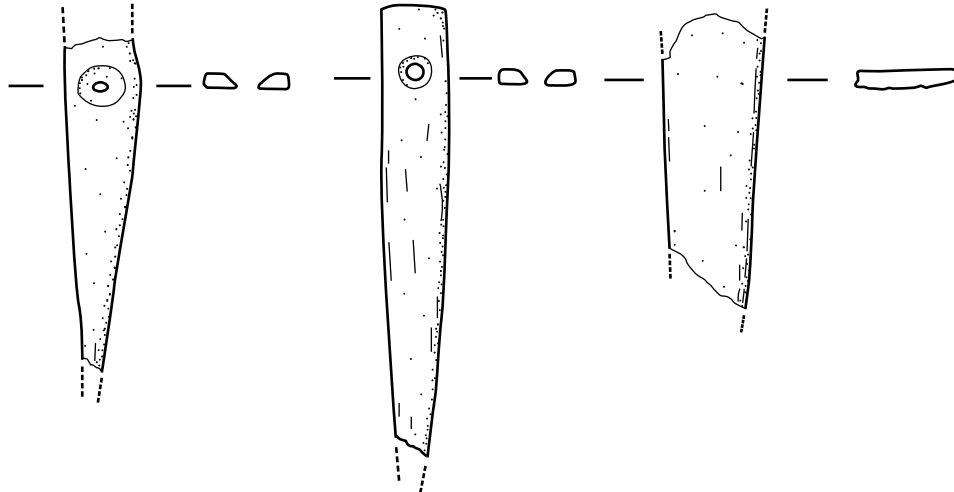

YYT-2-009-1

YYT-2-009-2

YYT-2-010-1

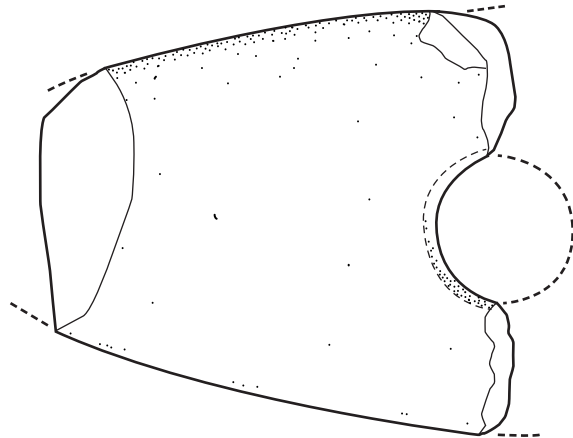

YYT-1991

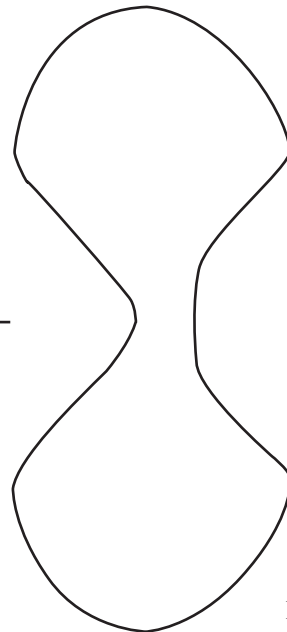
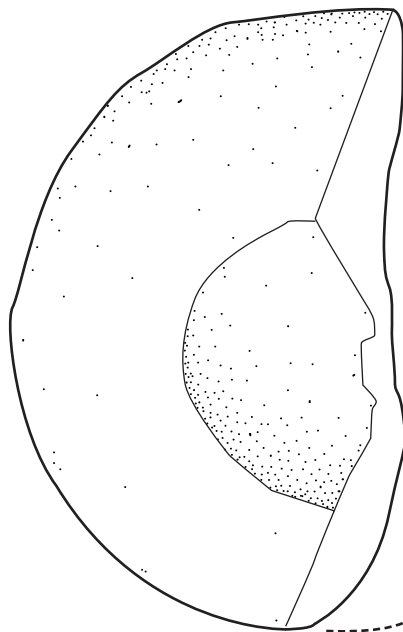
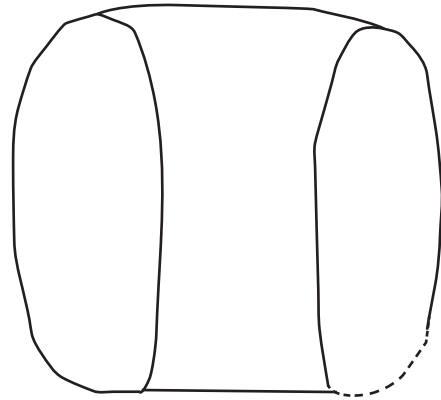

HT35-96-A715

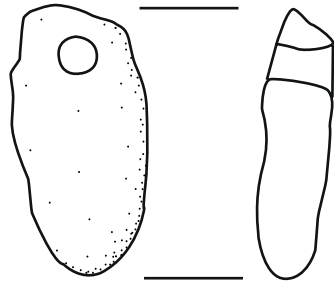

35HT-96-Z415

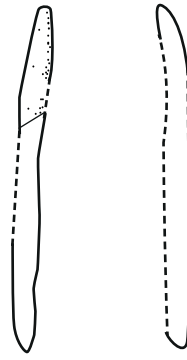

Çizim 91

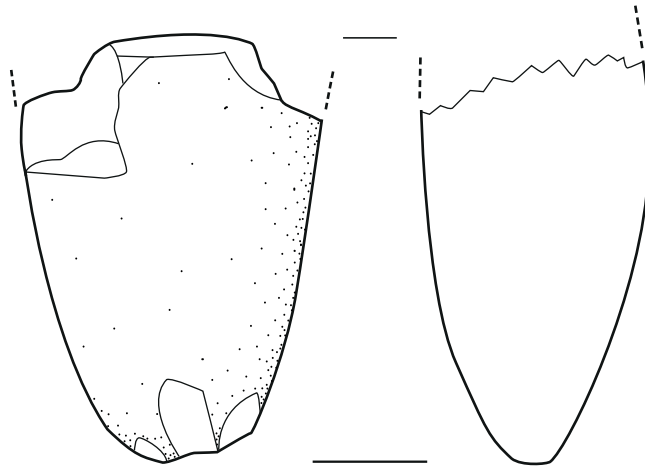

Çizim 120

Madra River Delta small finds (1:1)

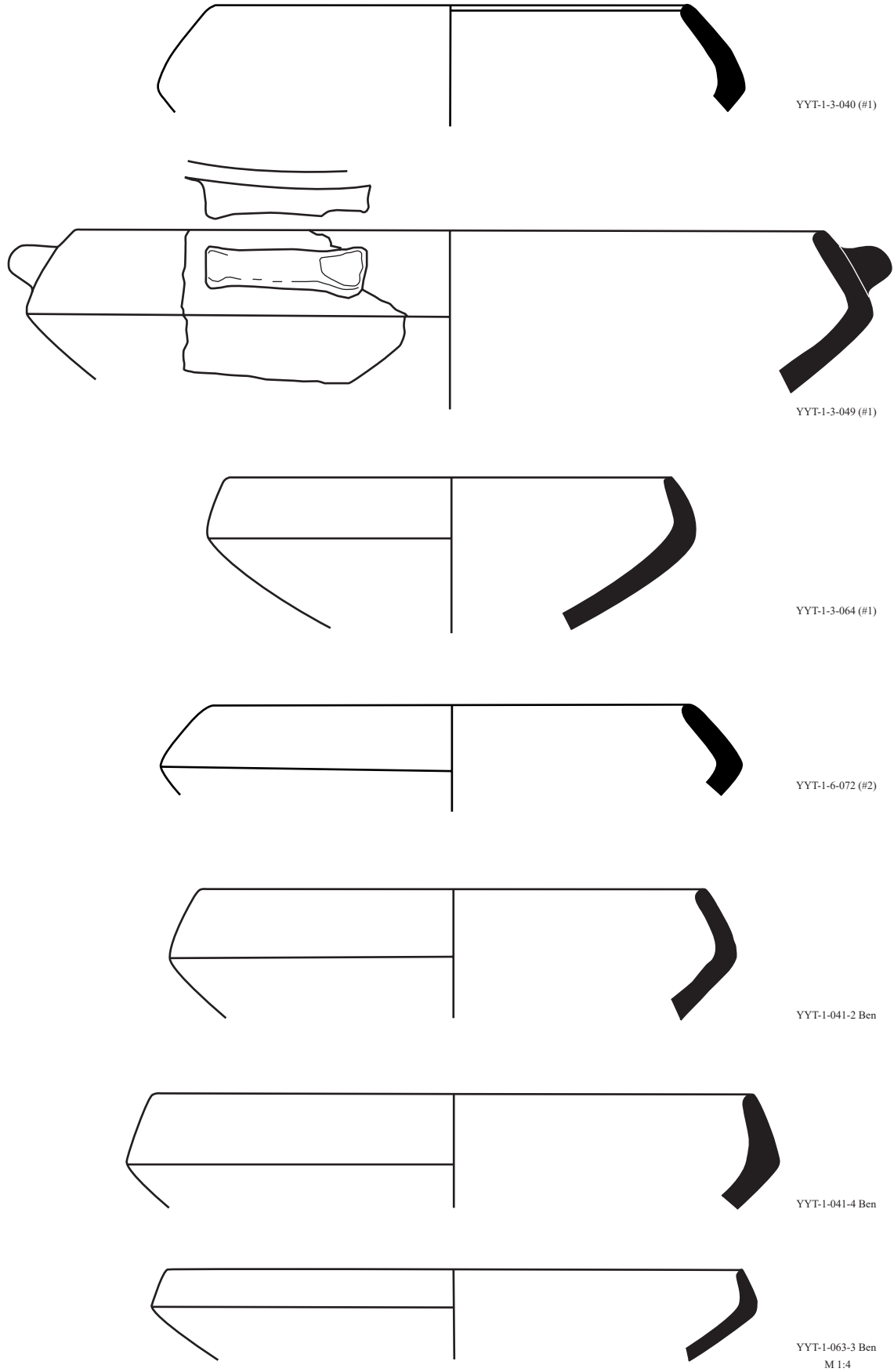

Yeni Yeldeğirmen - Excavations Shallow bowl 1a (M 1:2)

Figure 27

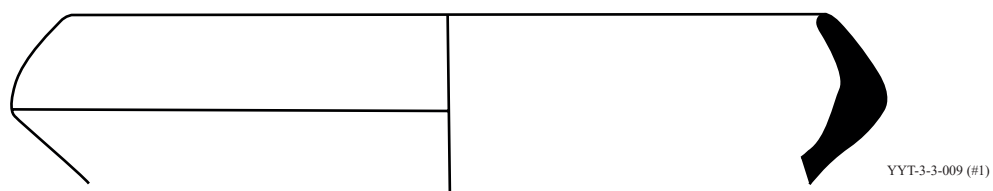
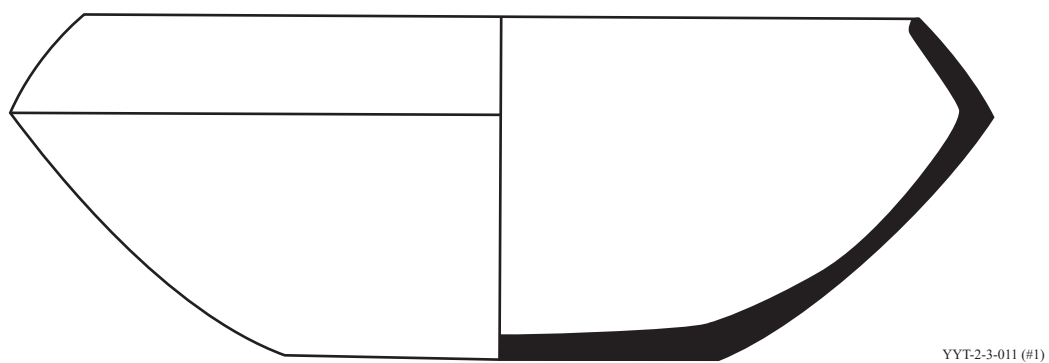
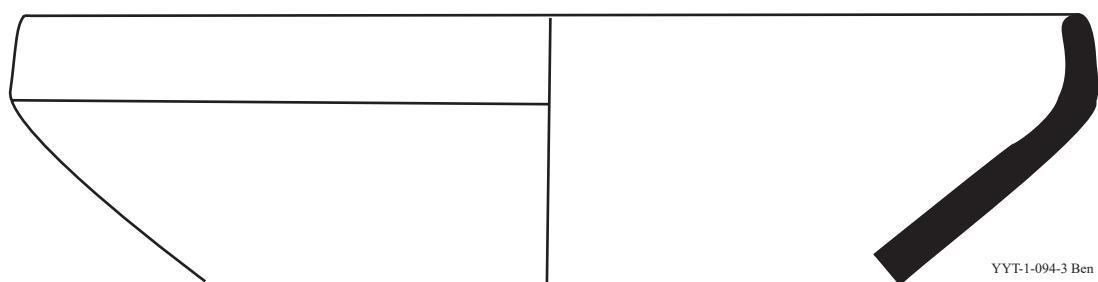
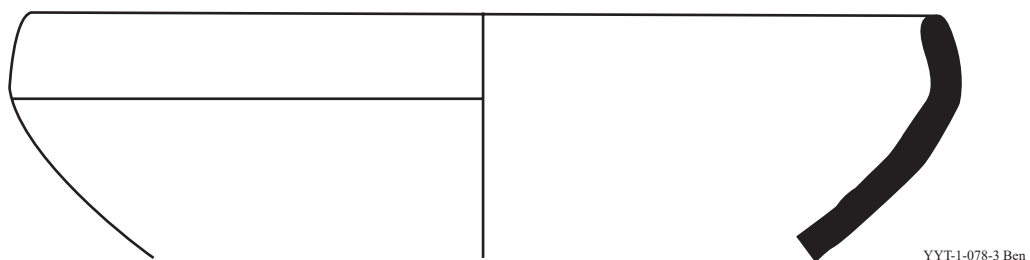
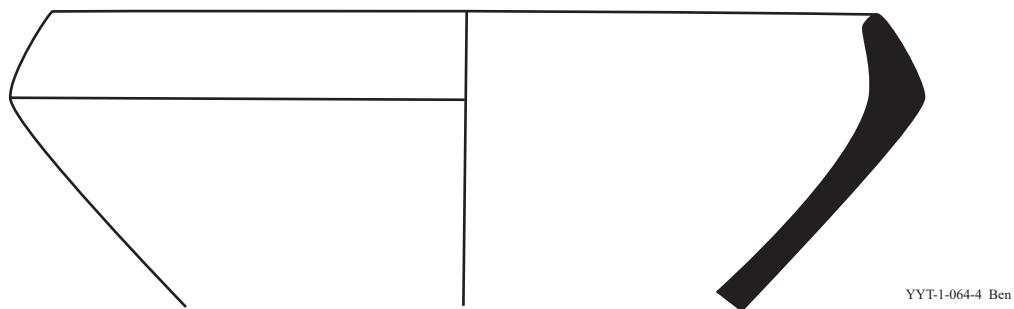

Yeni Yeldeğirmentepe - Excavations Shallow bowl 1a (M 1:2)

Figure 28

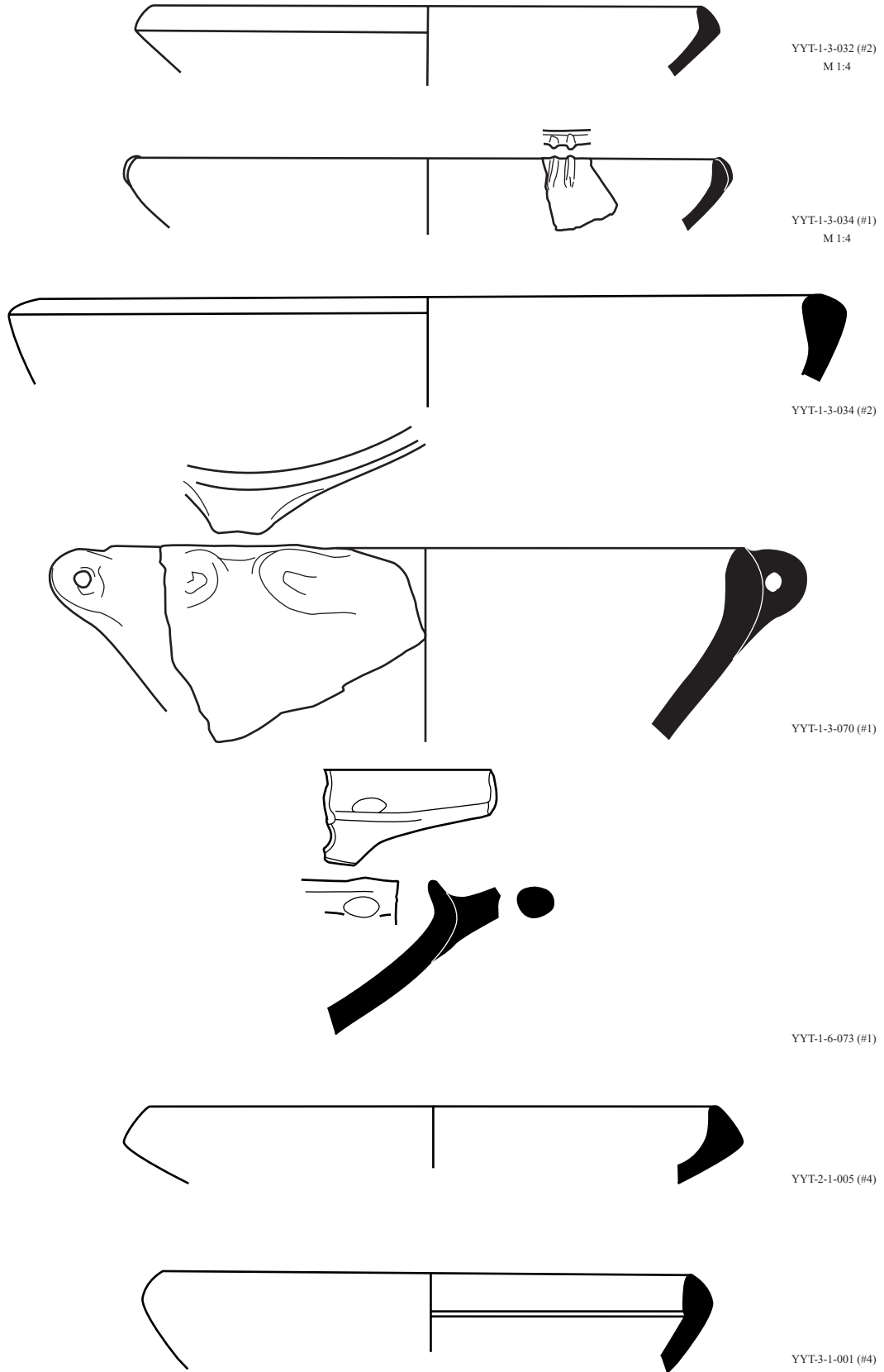

Yeni Yeldeğirmen - Excavations Shallow bowl 1b (M 1:2)

Figure 29

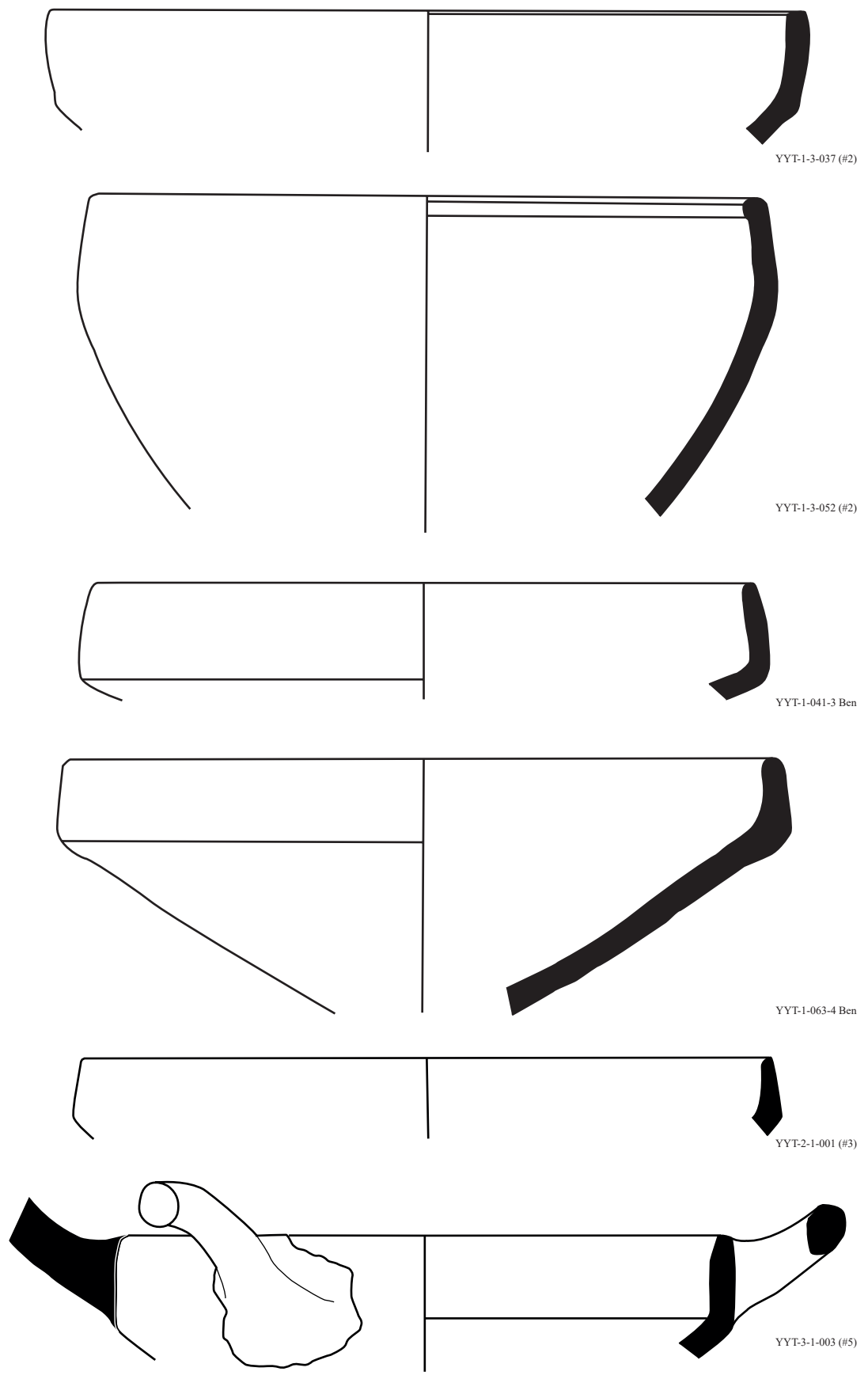

Yeni Yeldegirmentepe - Excavations Shallow bowl 2 (M 1:2)

Figure 30

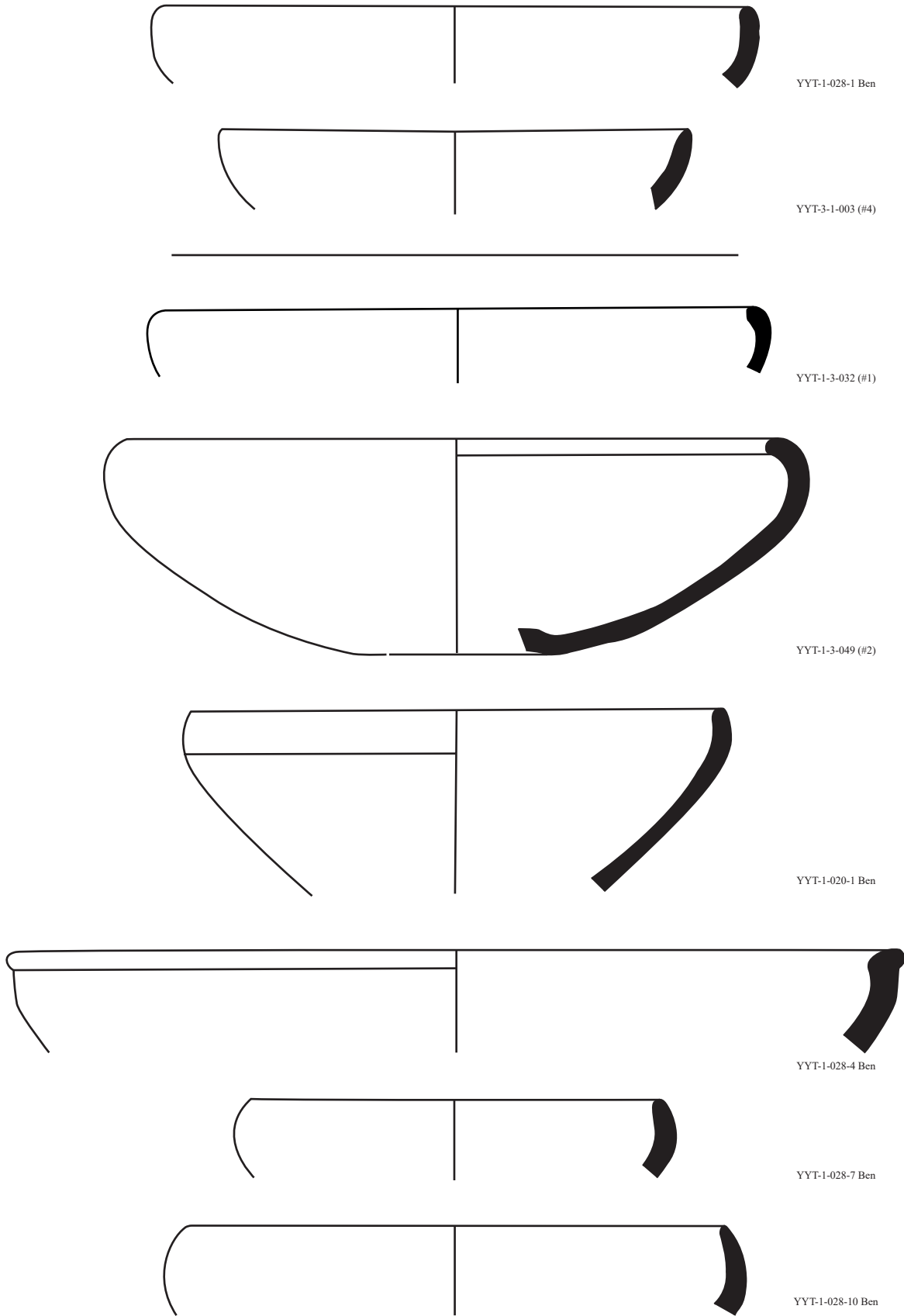

Yeni Yeldegirmentepe - Excavations Shallow bowl 3, Shallow bowl 4 (M 1:2)

Figure 31

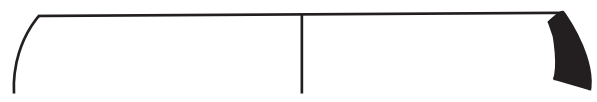

YYT-1-069-3 Ben

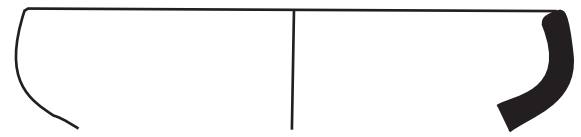

YYT-1-078-2 Ben

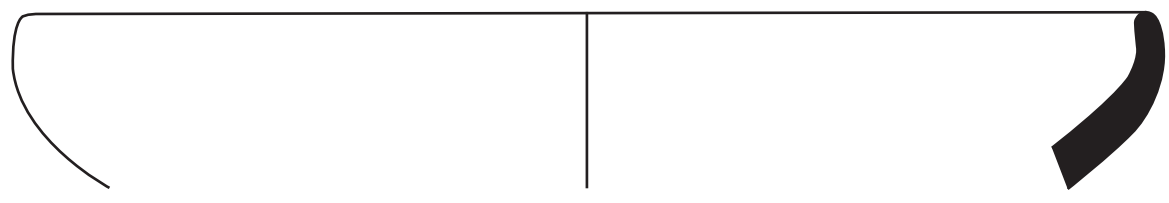

YYT-1-078-6 Ben

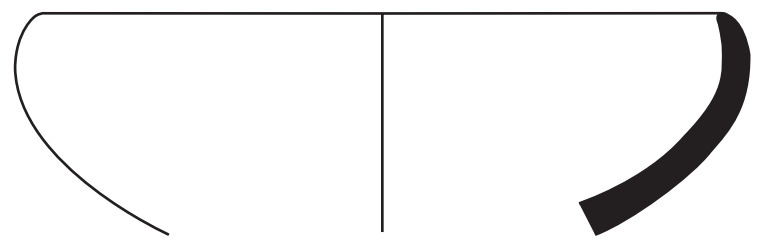

YYT-1-078-9 Ben

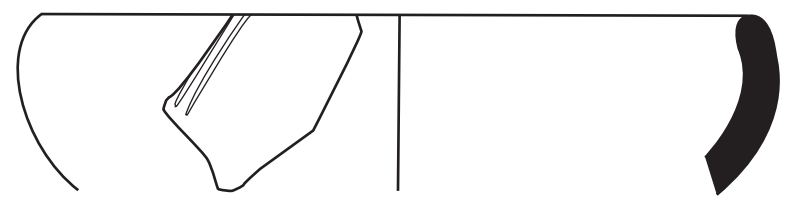

YYT-1-078-10 Ben

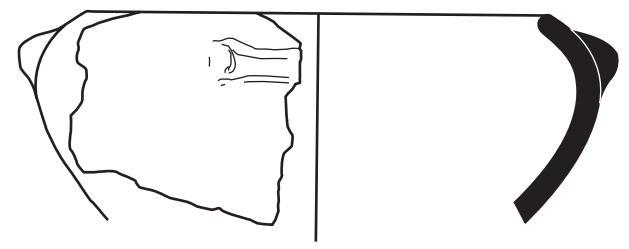

YYT-2-1-009 (#2)

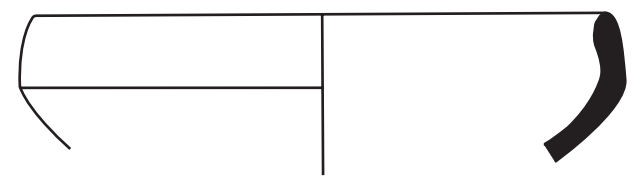

YYT-3-1-001 (#1)

Yeni Yeldegirmentepe - Excavations Shallow bowl 4 (M 1:2)



Figure 32

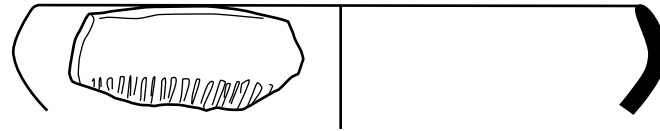

YYT-3-1-003 (#2)



YYT-1-6-072 (#4)



YYT-3-1-003 (#3)

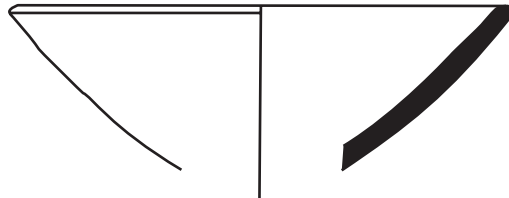

YYT-1-3-040 (#2)

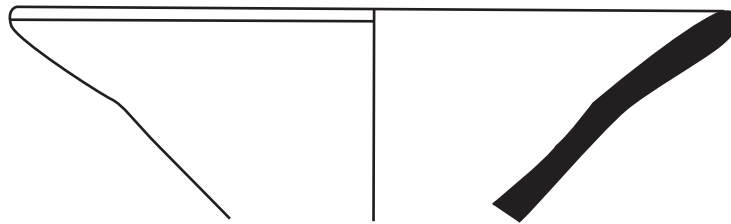

YYT-1-041-10 Ben

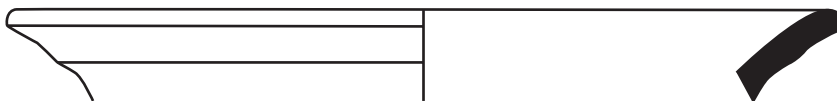

YYT-1-028-2 Ben

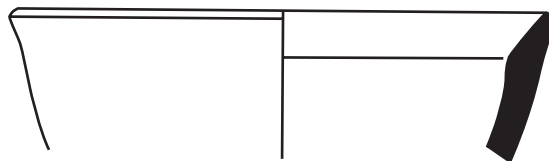

YYT-1-3-052 (#1)

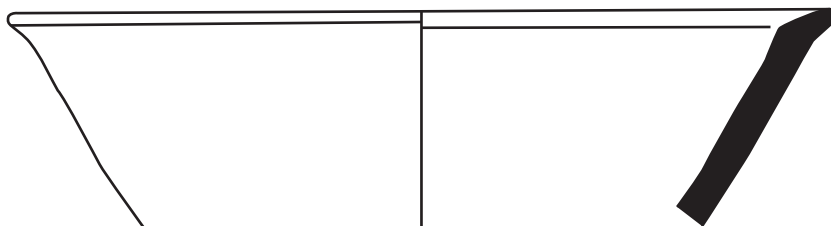

YYT-1-063-5 Ben

Yeni Yeldeğirmentepe - Excavations Shallow bowl 4, Shallow bowl 5, Shallow bowl 7  
Shallow bowl 9 (M 1:2)

Figure 33

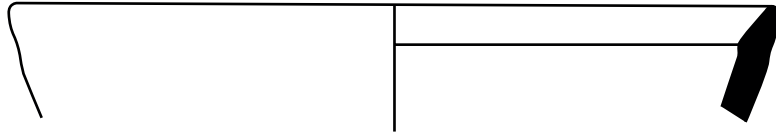

YYT-2-1-003 (#2)

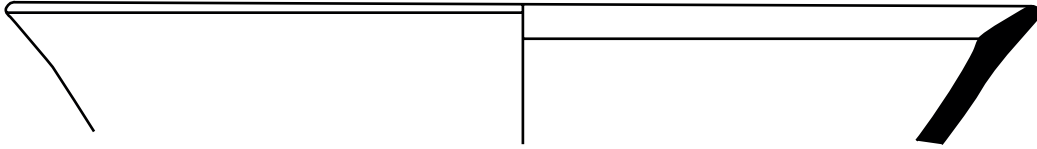

YYT-2-3-012 (#1)

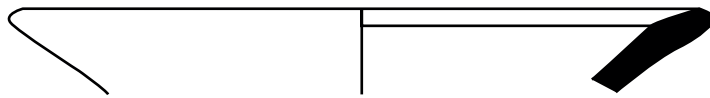

YYT-3-1-007 (#1)

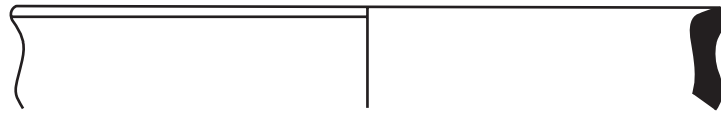

YYT-1-028-9 Ben

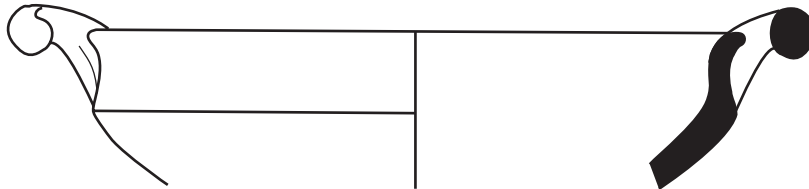

YYT-3-1-005 (#1)

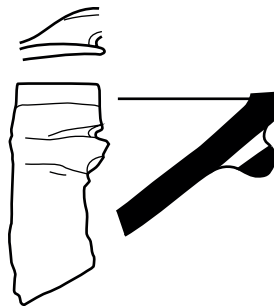

YYT-2-3-012 (#2)

Figure 34

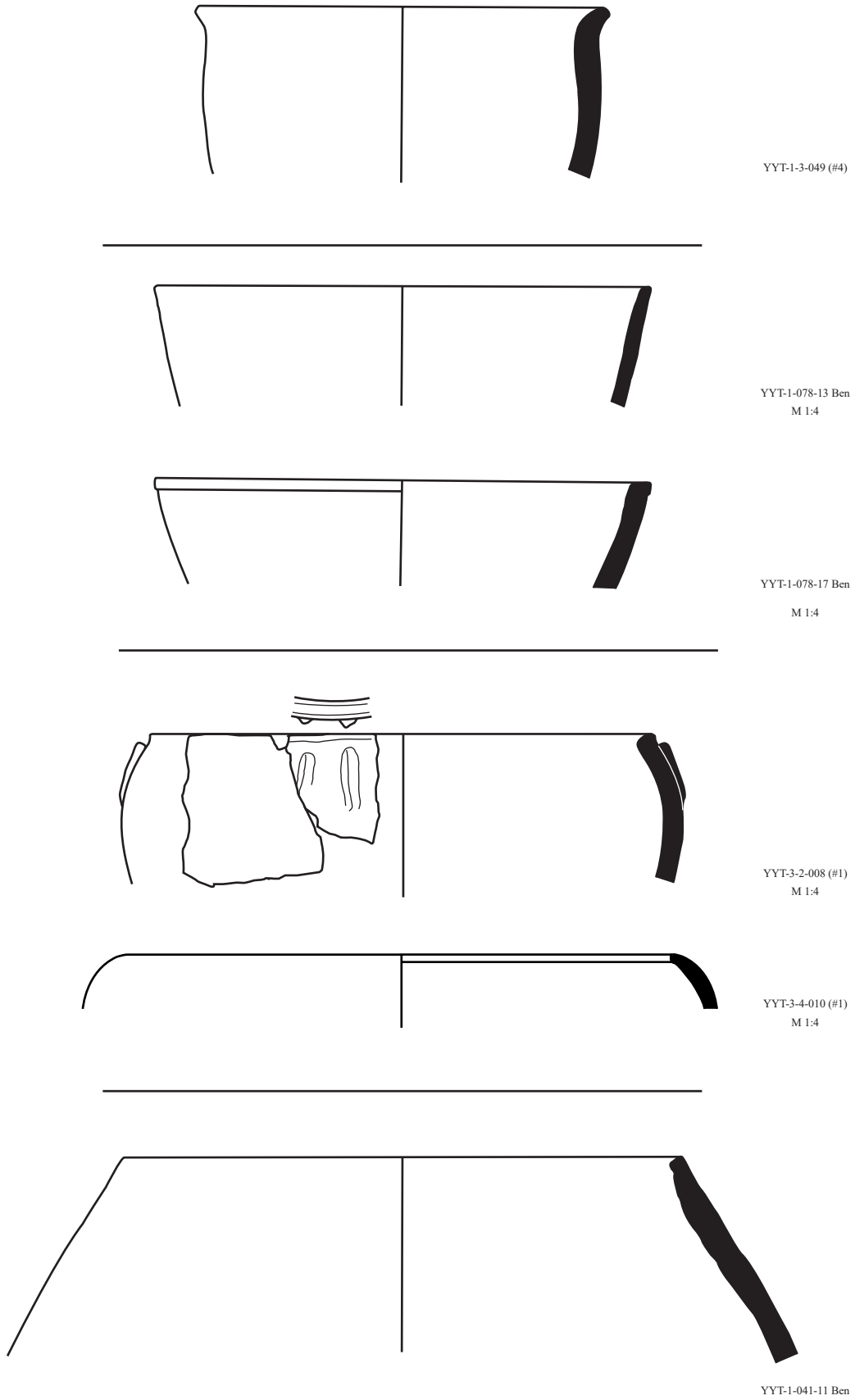

Yeni Yeldeğirmen - Excavations Deep bowl 1, Deep bowl 2, Deep bowl 4, Narrow-mouthed jar 1 (M 1:2)

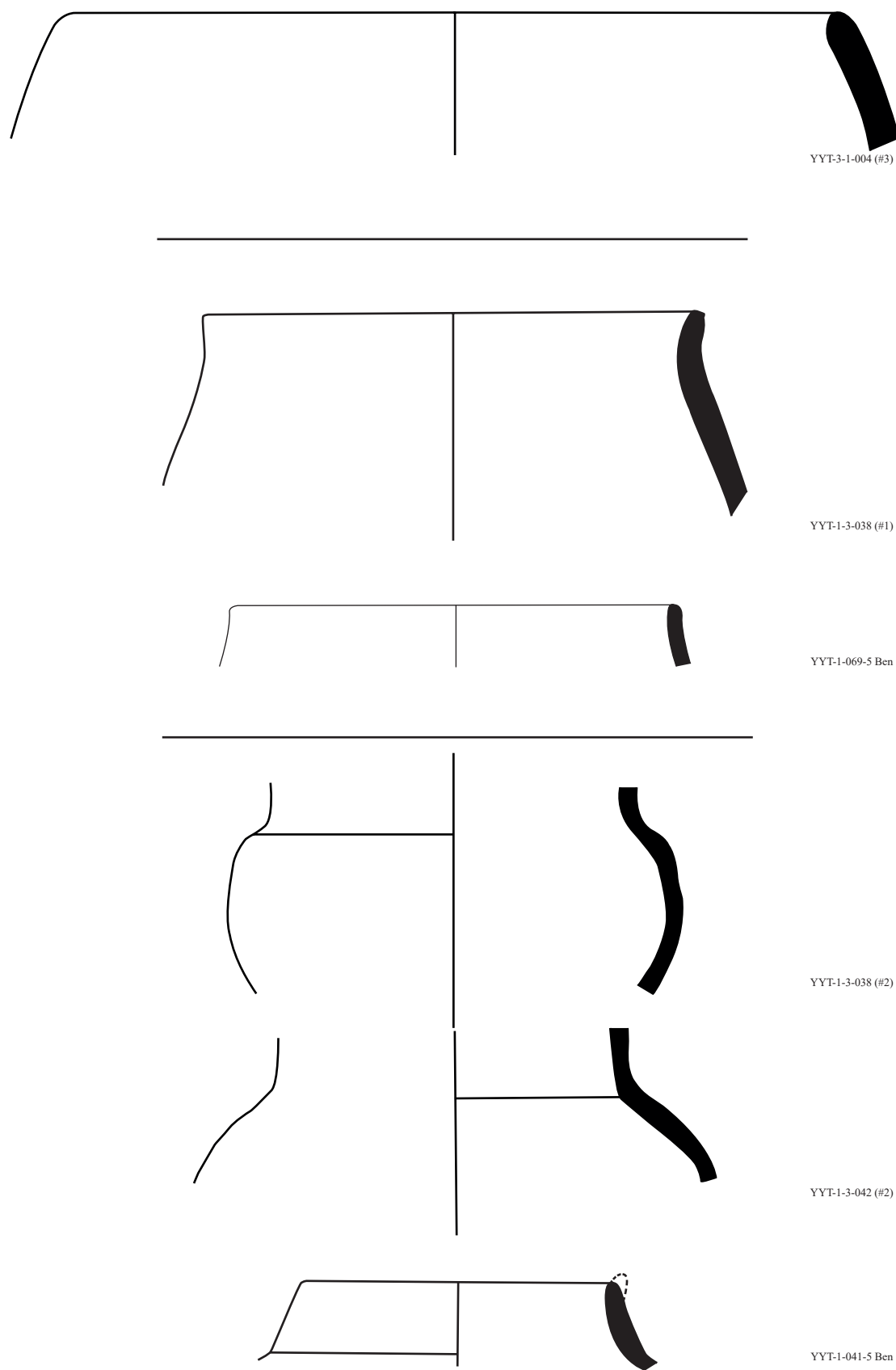

Yeni Yeldeğirmentepe - Excavations Narrow-mouthed jar 1, Narrow-mouthed jar 2, Neck-jar 1 (M 1:2)

Figure 36

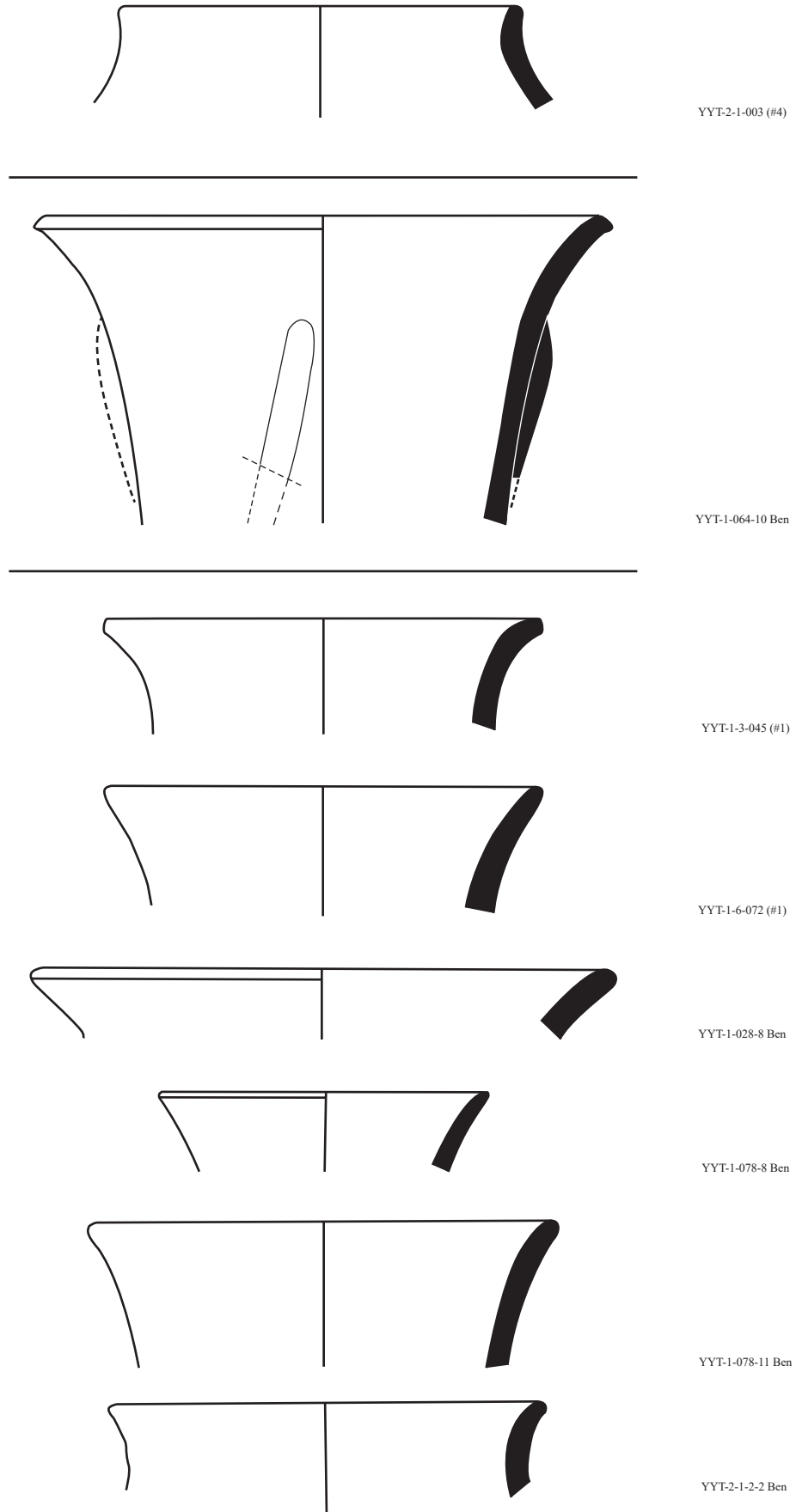

Yeni Yeldeğirmen-tepe - Excavations Neck-jar 1, Neck-jar 2, Neck-jar 3 (M 1:2)

Figure 37

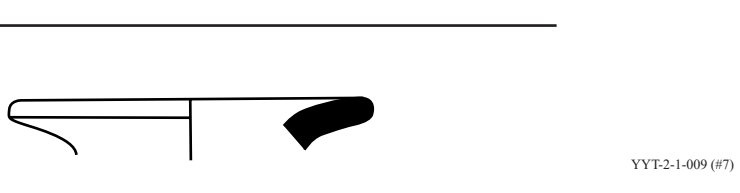
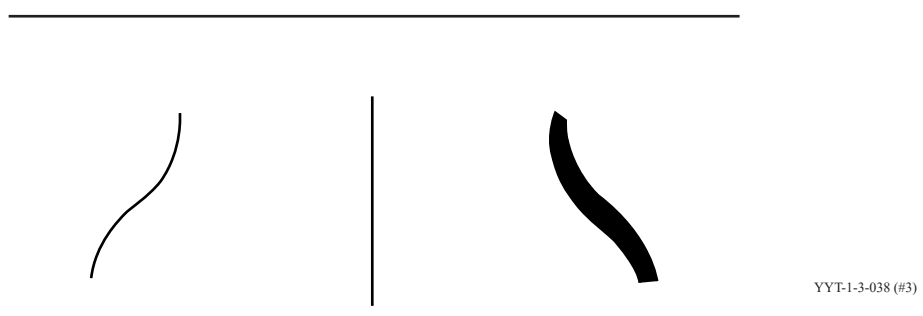
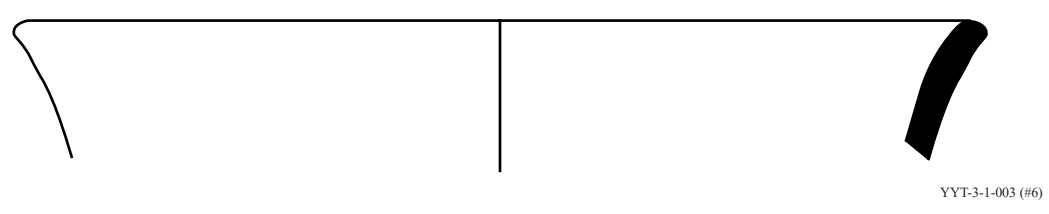
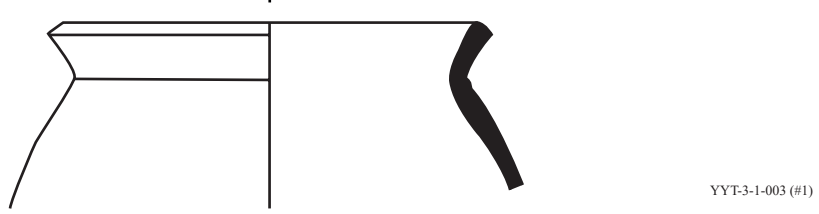
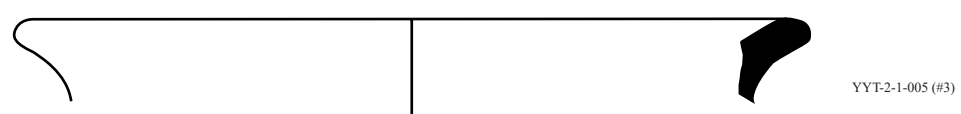
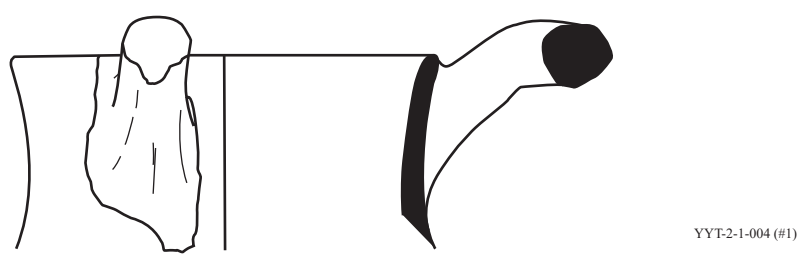
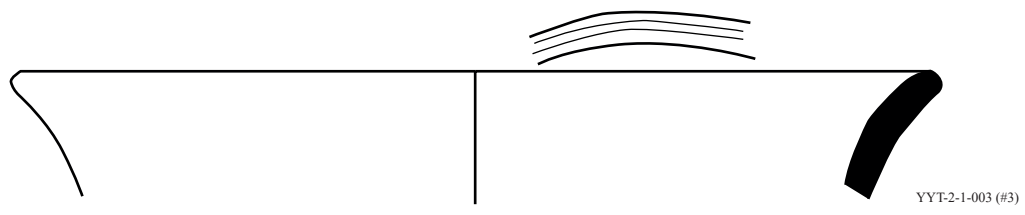

Yeni Yeldeğirmentepe - Excavations Neck-jar 3, Neck-jar 0, Flask 1 (M 1:2)

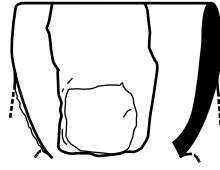

YYT-1-3-060 (#1)

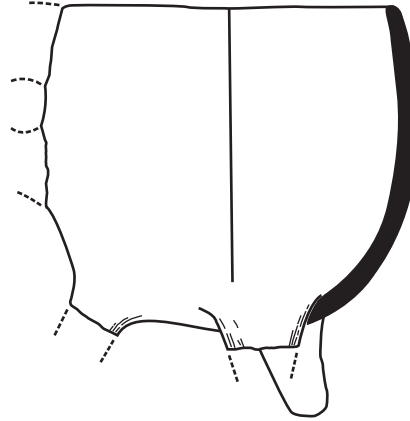

YYT-1-057-1 Ben

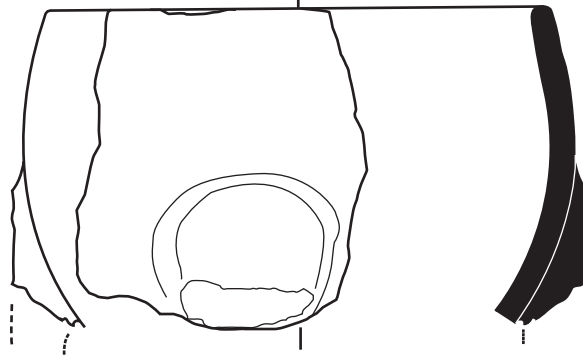

YYT-2-1-003 (#1)



YYT-1-041-8 Ben

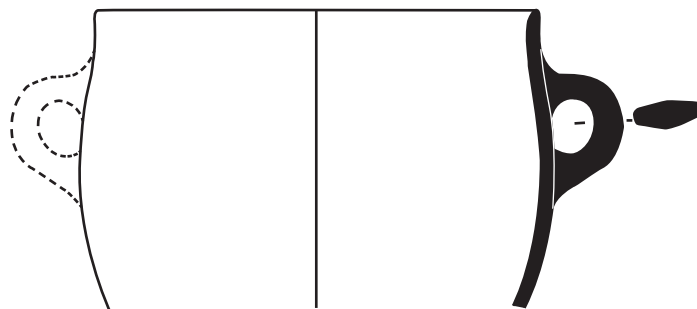

YYT-1-062-7 Ben  
M 1:4

Figure 39

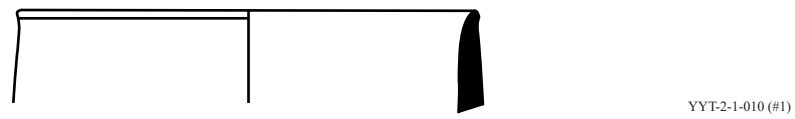
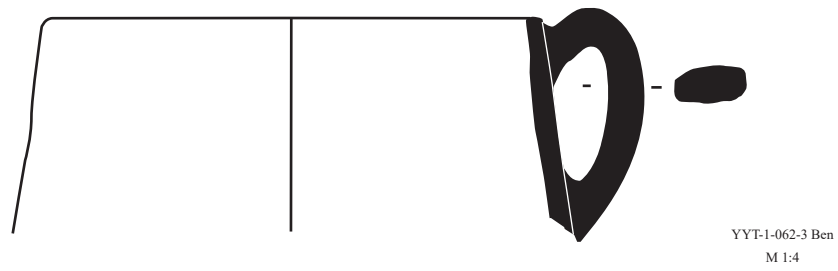
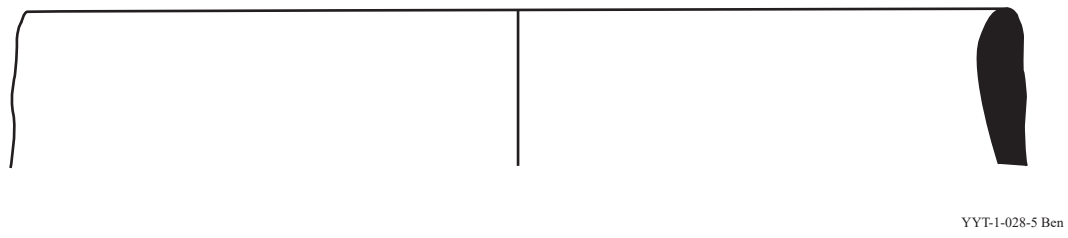
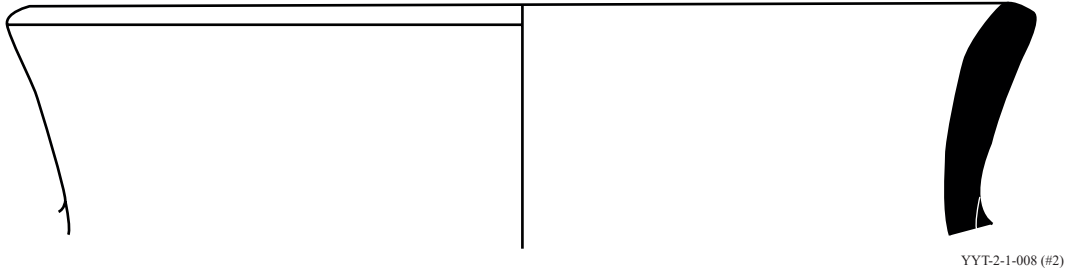

Yeni Yeldeğirmentepe - Excavations Jar 2, Jar 3 (M 1:2)



Figure 40

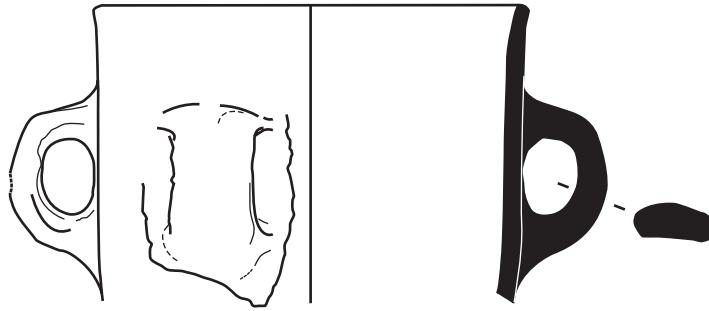

YYT-1-3-060 (#2)  
M 1:4

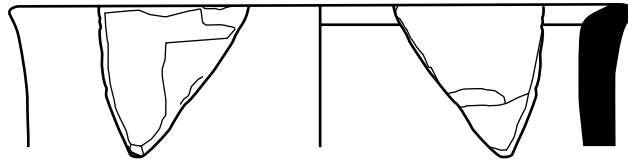

YYT-3-1-004 (#1)

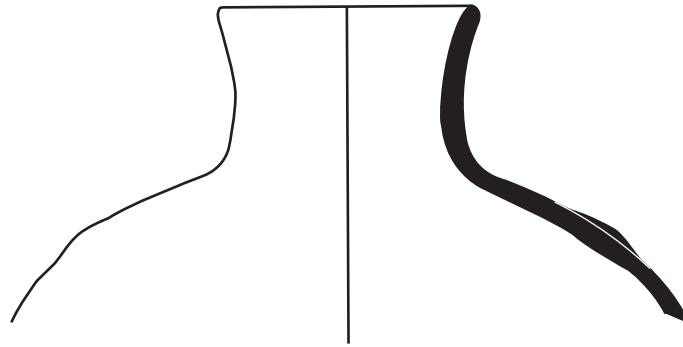

YYT-2-1-2 (#1)  
M 1:4

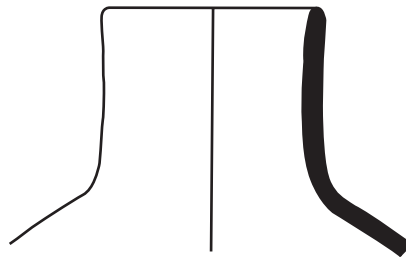

YYT-2-1-009 (#1)  
M 1:4

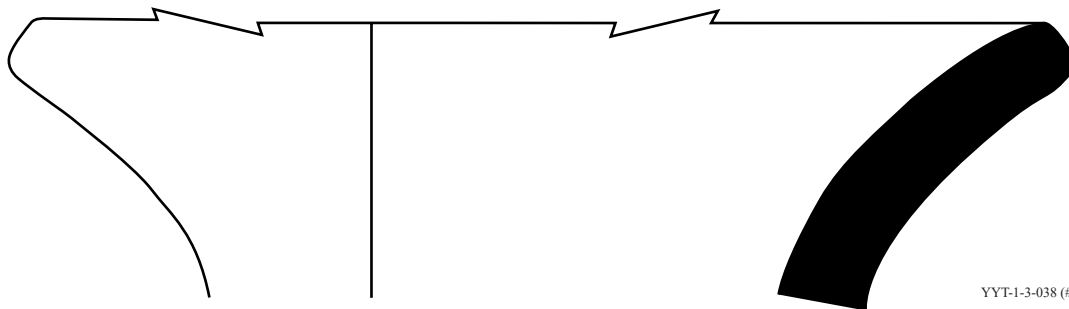

YYT-1-3-038 (#6)

Yeni Yeldeğirmentepe - Excavations Jar 4, Amphora 1, Amphora 2, Pithos (M 1:2)

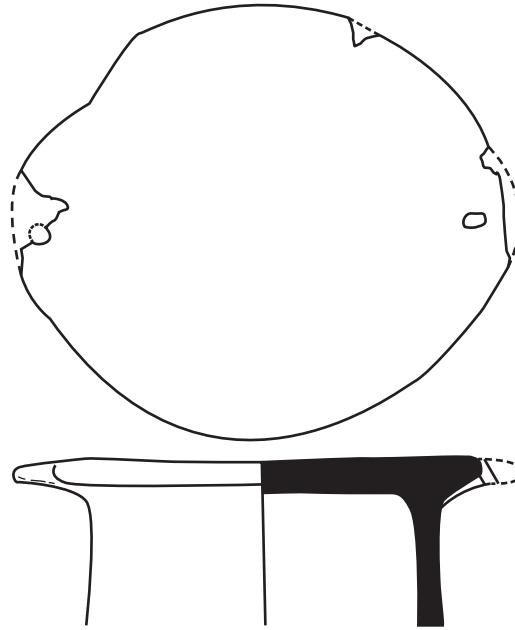

YYT-1-062-1 Ben



YYT-2-1-003 (#5)

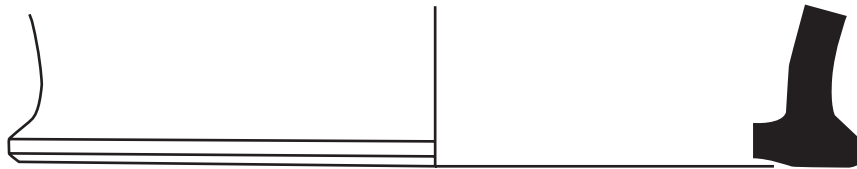

YYT-2-2-011 (#1)



YYT-3-3-009 (#2)

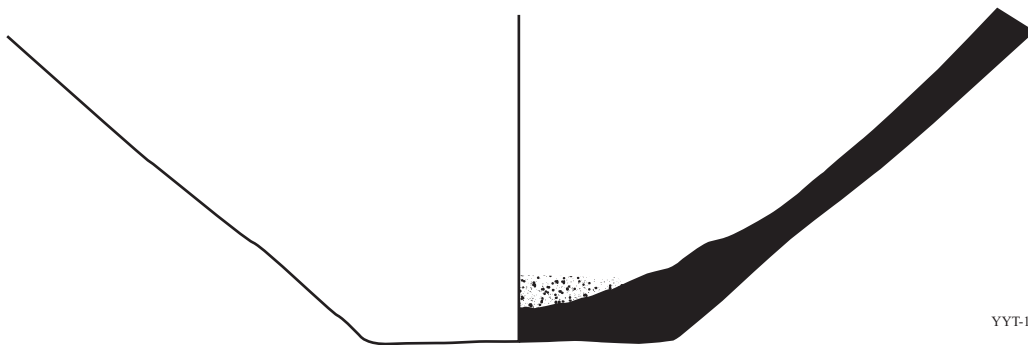

YYT-1-020-4 Ben

Figure 42

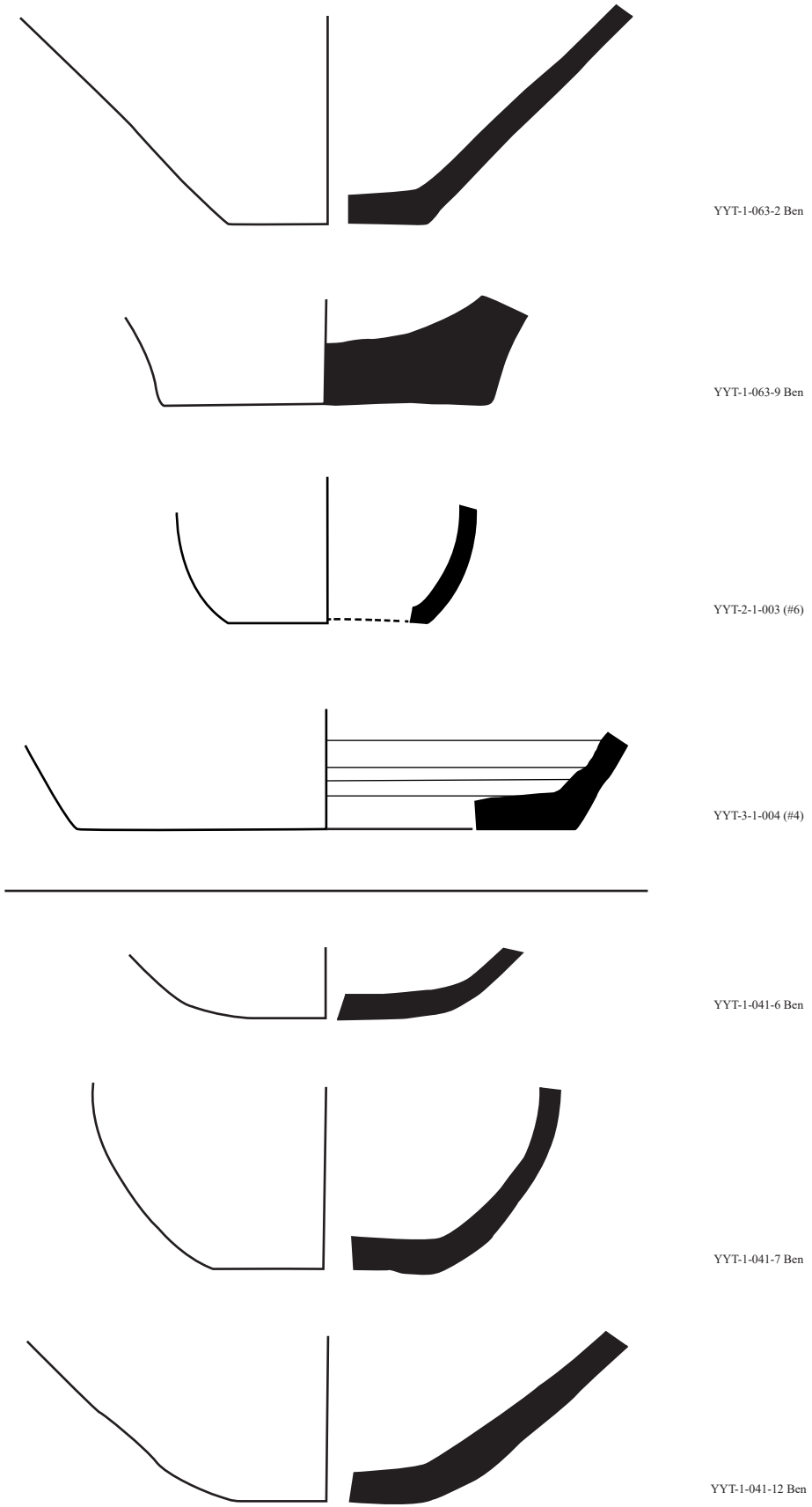

Yeni Yeldeğirmentepe - Excavations Base 2A, Base 2B (M 1:2)

Figure 43

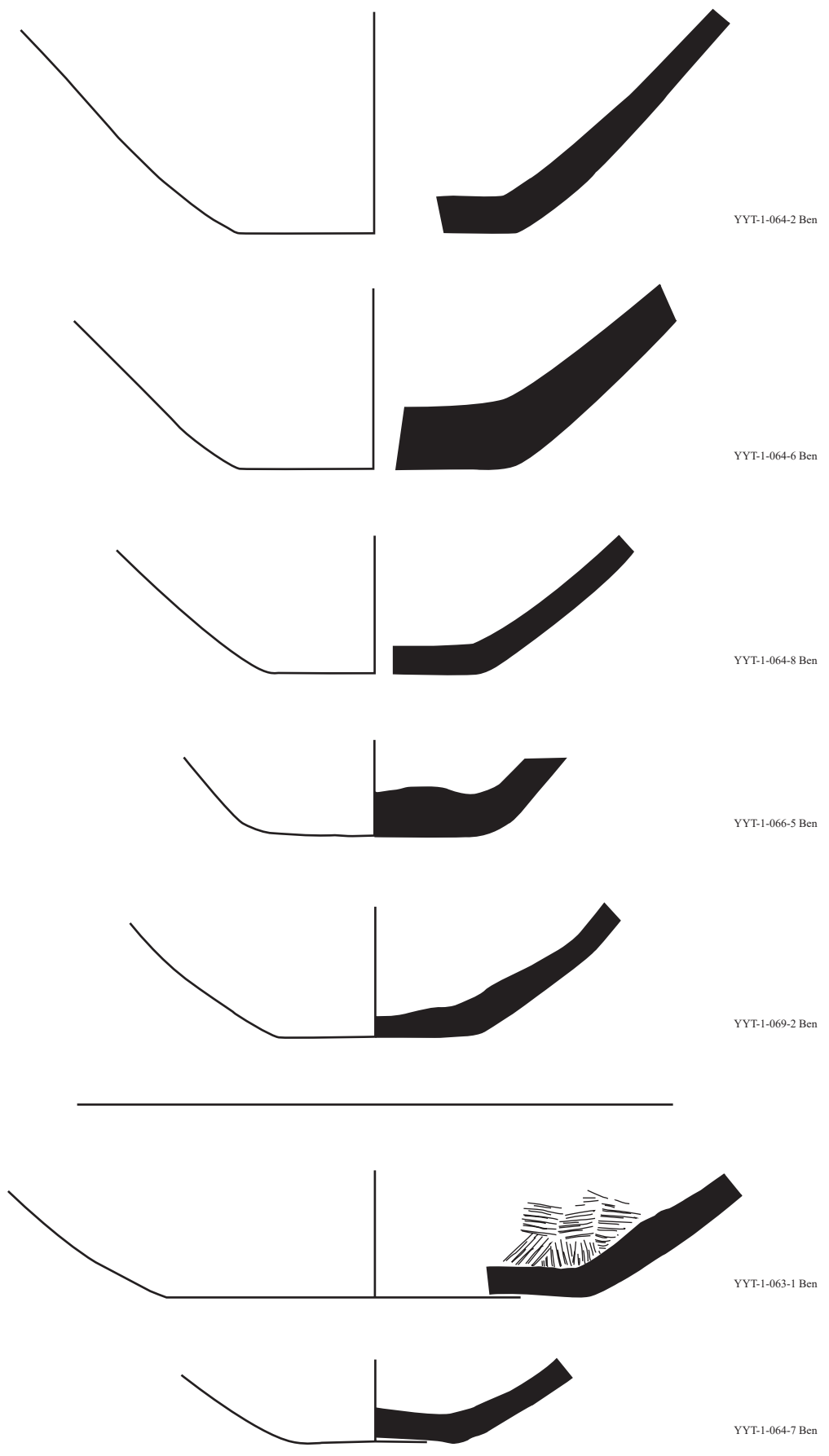

Yeni Yeldeğirmen - Excavations Base 2B, Base 3 (M 1:2)

Figure 44



YYT-1-064-9 Ben



YYT-2-1-005 (#1)



YYT-2-1-009 (#6)

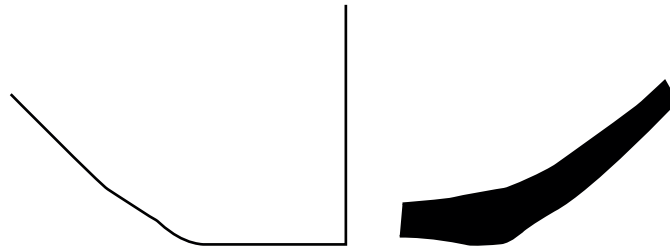

YYT-2-1-010 (#2)

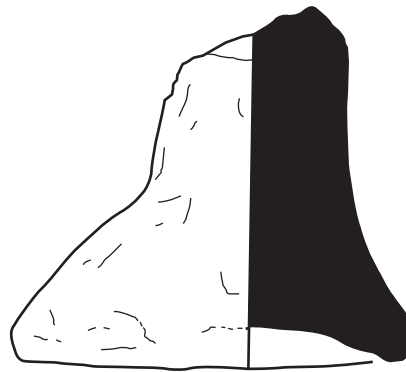

YYT-1-069-6 Ben

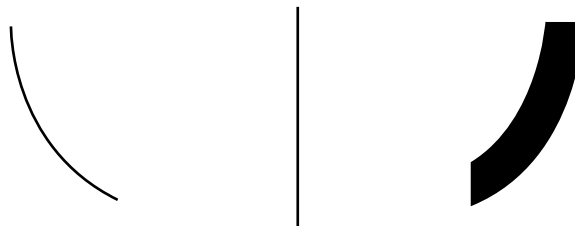

YYT-2-2-011 (#2)

Yeni Yeldegirmentepe - Excavations Base 3, Base 4, Base 5 (M 1:2)

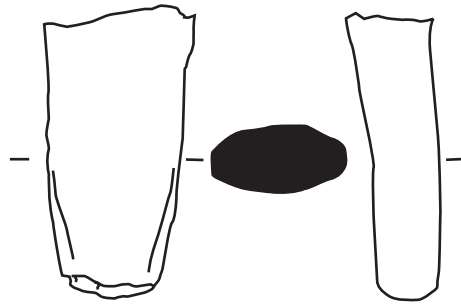

YYT-1-3-035 (#7)

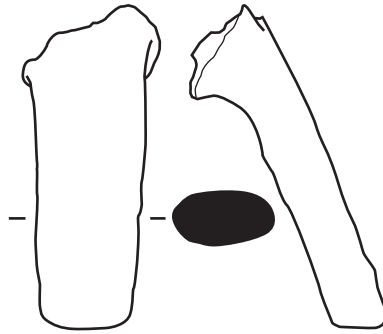

YYT-1-12-088 (#1)

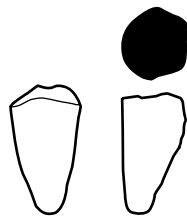

YYT-1-3-038 (#4)

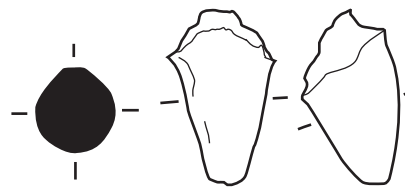

YYT-1-3-042 (#1)

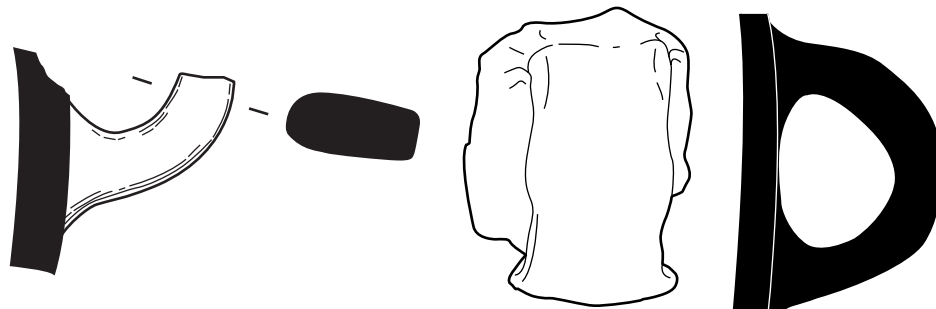

YYT-1-094-5 Ben

YYT-2-1-009 (#4)

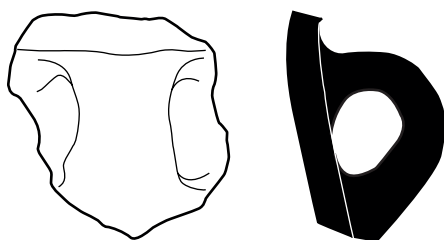

YYT-2-3-011 (#2)

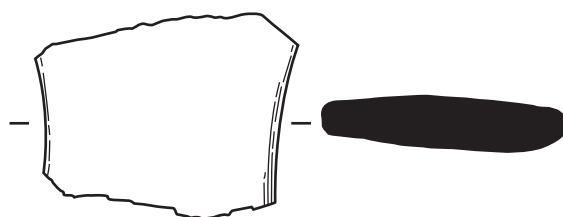

YYT-1-062-2 Ben

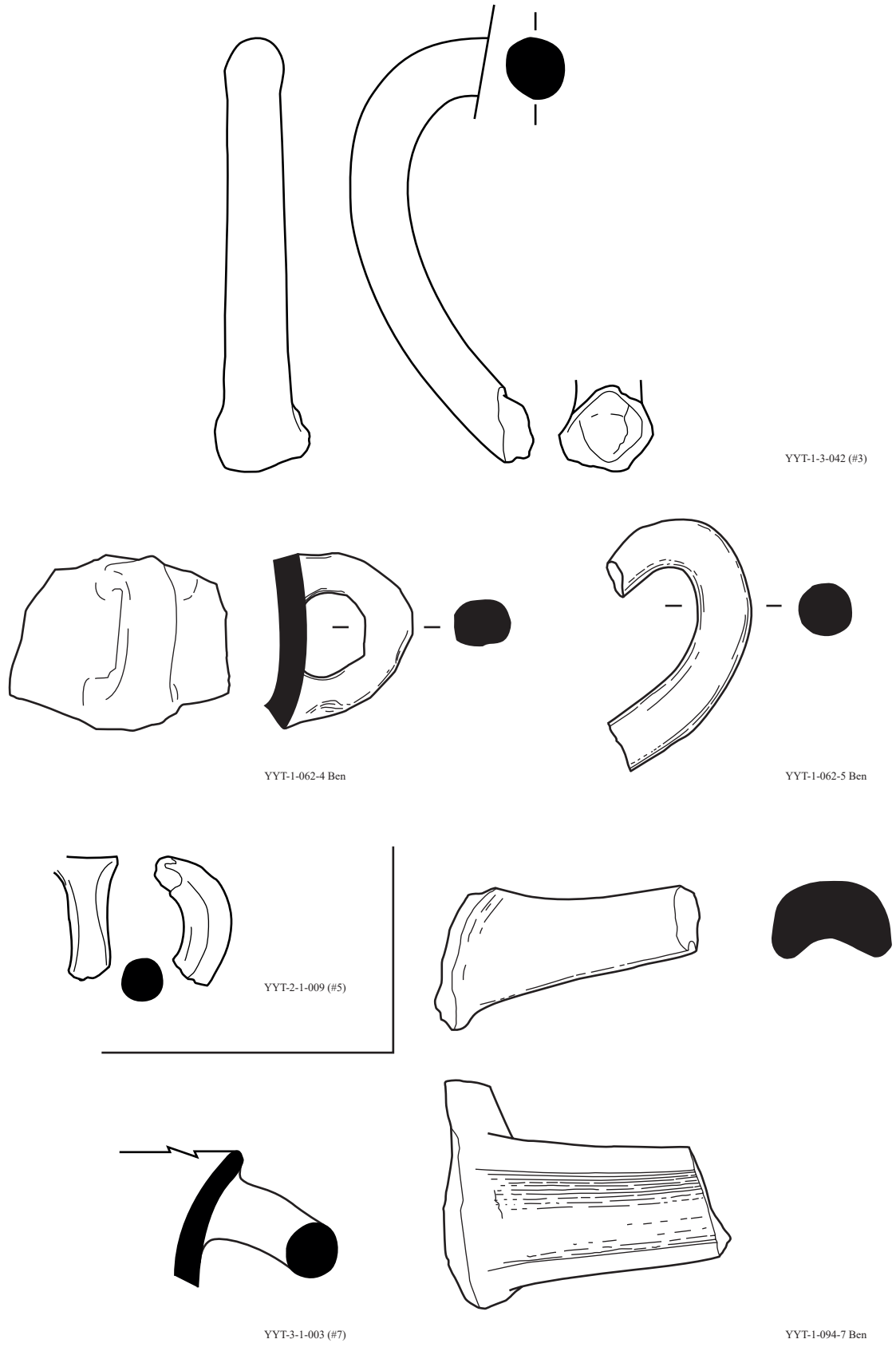

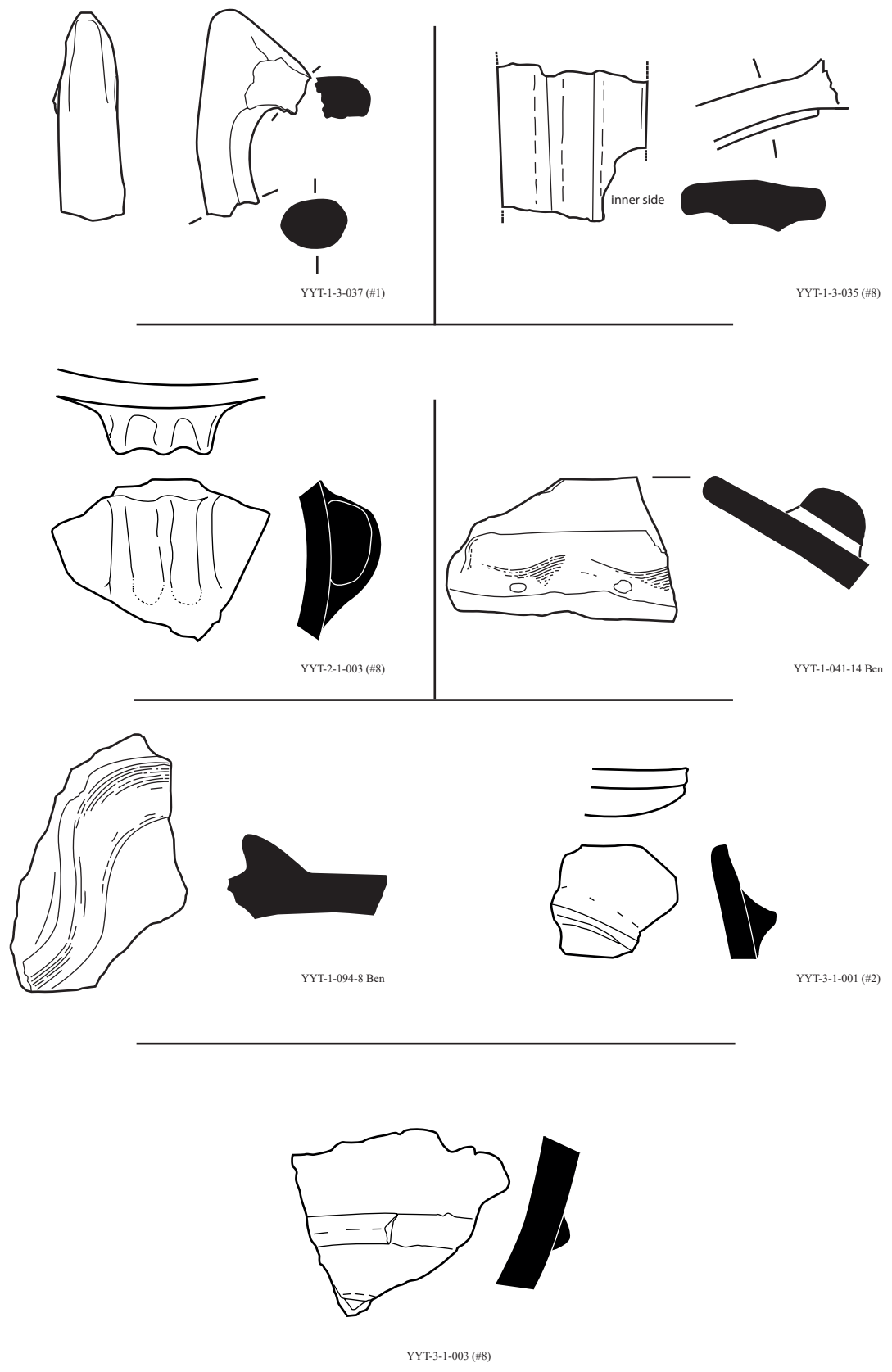

Yeni Yeldeğirmentepe - Excavations Handle 4, Handle 5, Knob handle 2, Bar handle 2, Applied bar 2, Applied bar 3 (M 1:2)



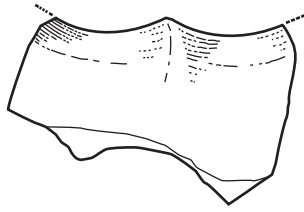

YYT-1-063-7 Ben

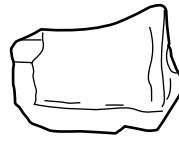

YYT-3-1-001 (#5)

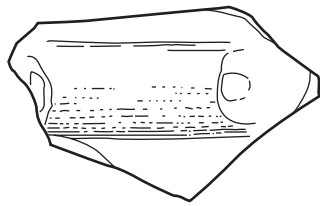

YYT-1-069-1 Ben



YYT-1-3-071 (#1)

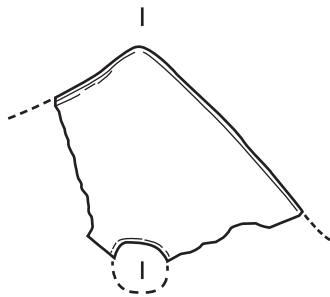

YYT-1-041-9 Ben

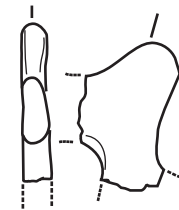

YYT-1-3-044 (#1)

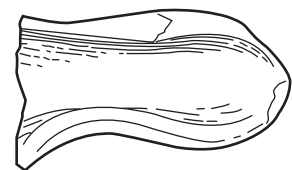

YYT-1-027-2 Ben

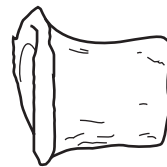

YYT-1-041-15 Ben

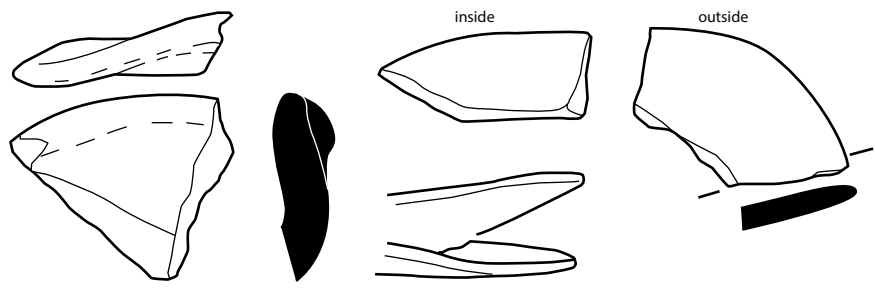

YYT-3-1-004 (#5)

YYT-3-1-005 (#2)

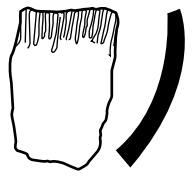

YYT-1-3-034 (#2)

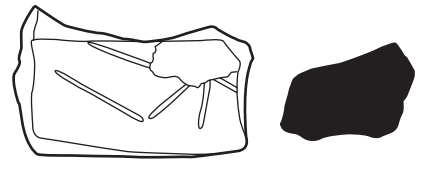

YYT-1-039-4 Ben



YYT-1-039-5 Ben

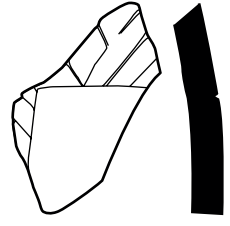

YYT-2-1-003 (#7)



YYT-2-1-004 (#2)

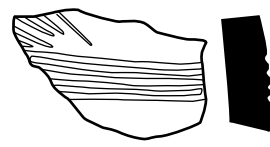

YYT-2-1-005 (#2)

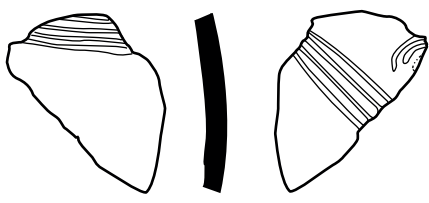

YYT-2-2-011 (#3)

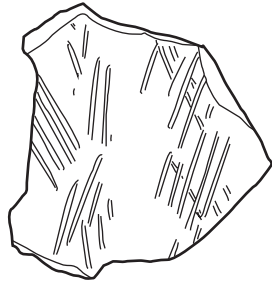

YYT-1-063-6 Ben

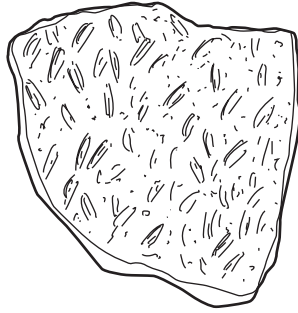

YYT-1-064-5 Ben



YYT-1-069-4 Ben

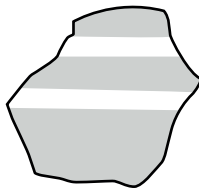

YYT-2-2-011 (#4)  
M 1:1

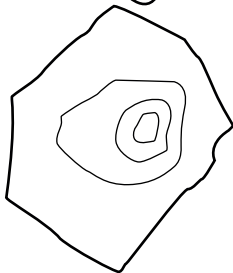

YYT-1-12-088 (#2)

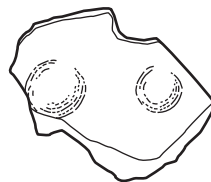

YYT-1-027-3 Ben

Yeni Yeldeğirmen-tepe - Excavations Characteristic wall fragment 2C, Characteristic wall fragment 3, Characteristic wall fragment 7 (M 1:2)

Figure 51

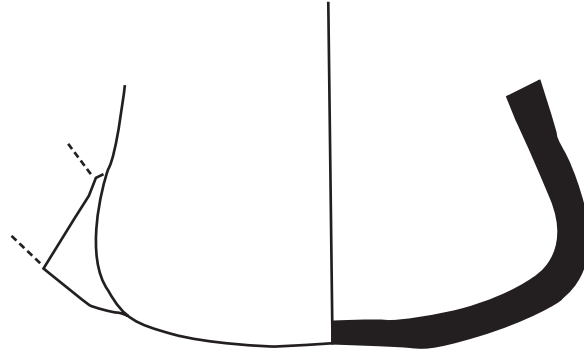

YYT-1-073-1 Ben  
M 1:1

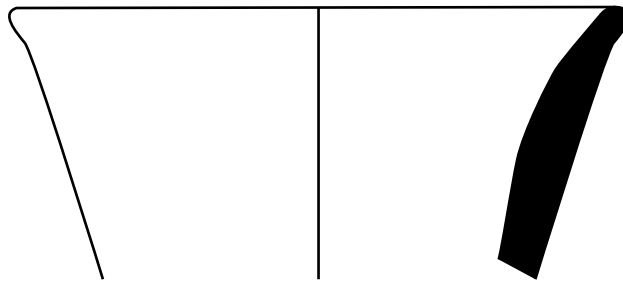

YYT-3-1-001 (#3)  
M 1:1

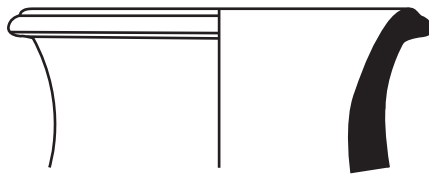

YYT-1-028-3 Ben

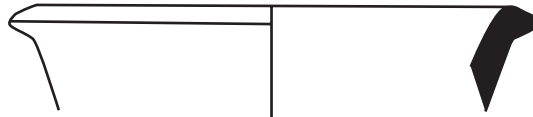

YYT-1-028-6 Ben

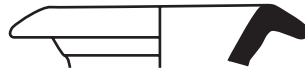

YYT-1-028-11 Ben

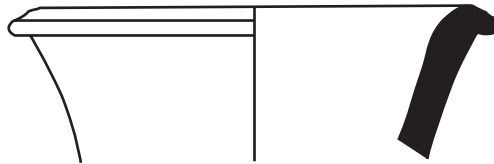

YYT-1-078-5 Ben

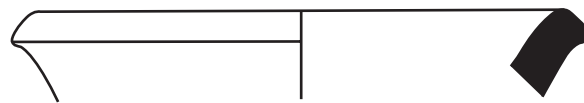

YYT-1-078-15 Ben

Yeni Yeldeğirmen-tepe - Excavations Depas, unclear shape, post EBA? (M 1:2)

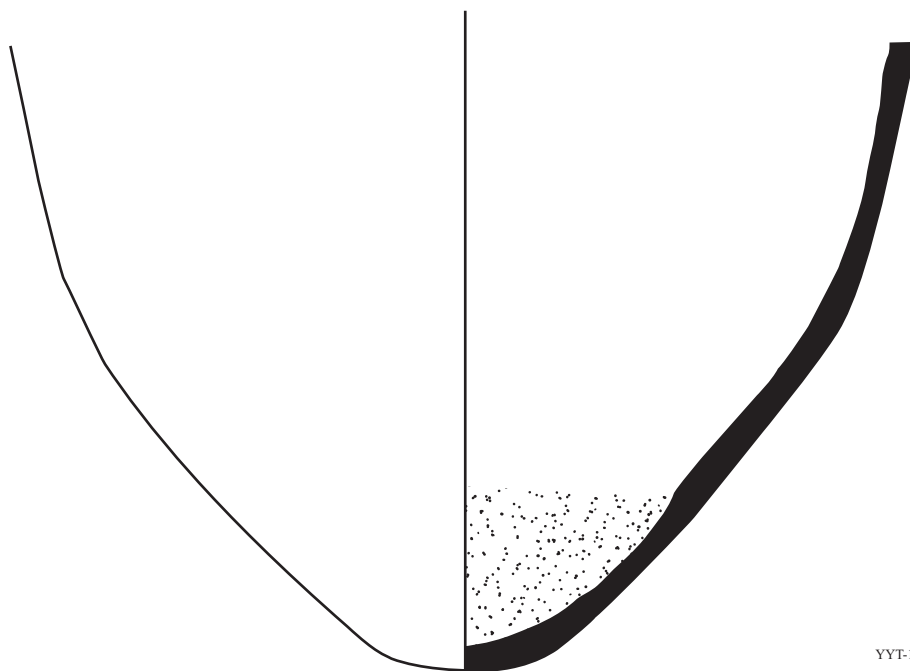

YYT-1-062-6 Ben

**Yeni Yeldeğirmen-tepe - Excavations post EBA? (M 1:2)**

Figure 53

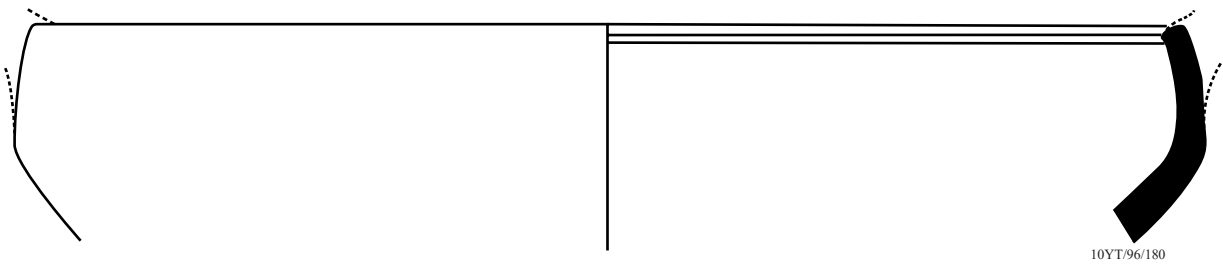
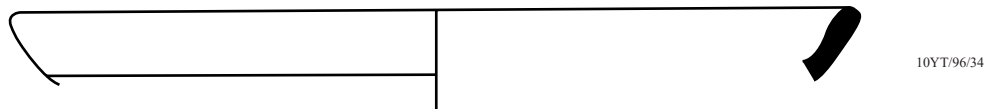
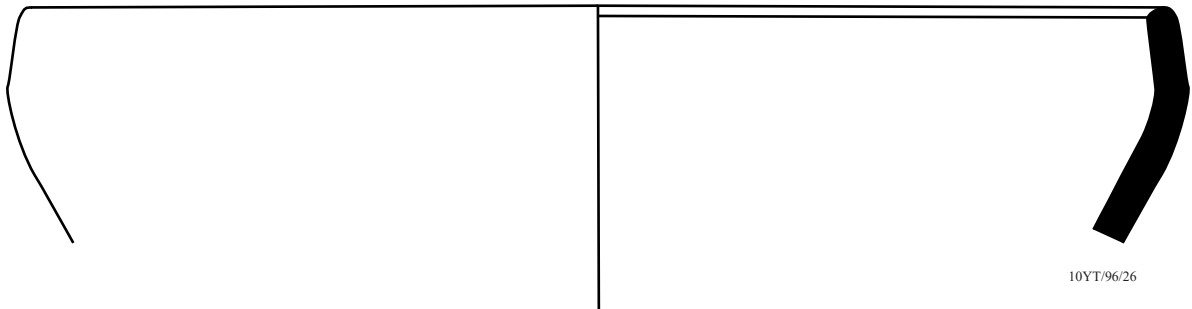
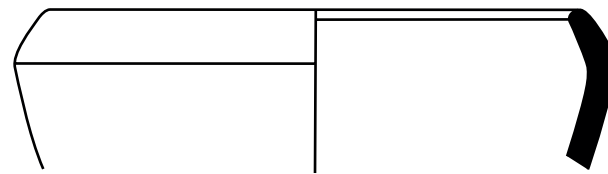
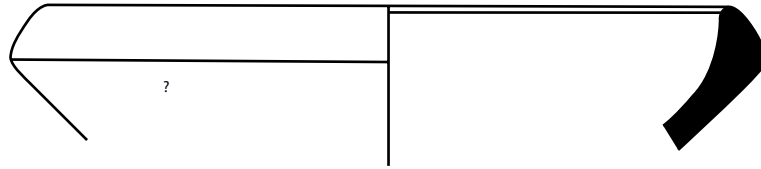
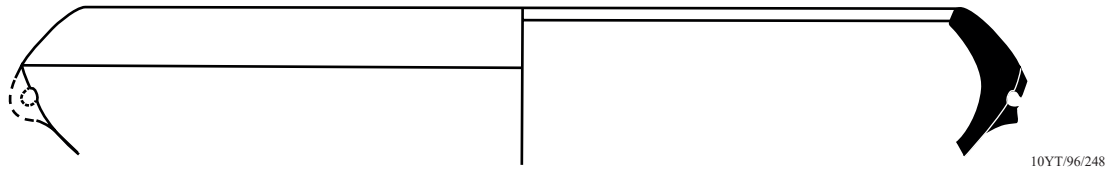

Yeni Yeldeğirmenetepe - Survey Shallow bowl 1a, Shallow bowl 1b, Shallow bowl 2 (M 1:2)

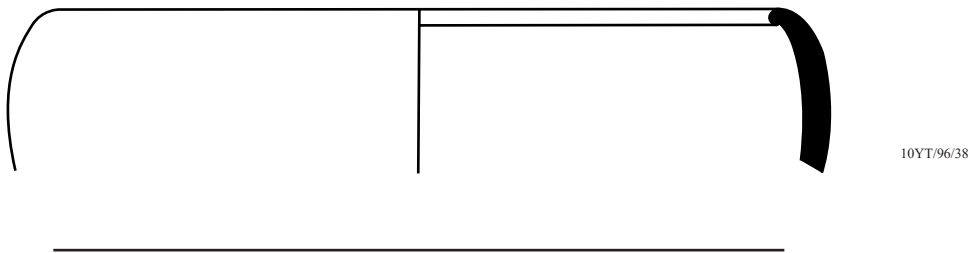
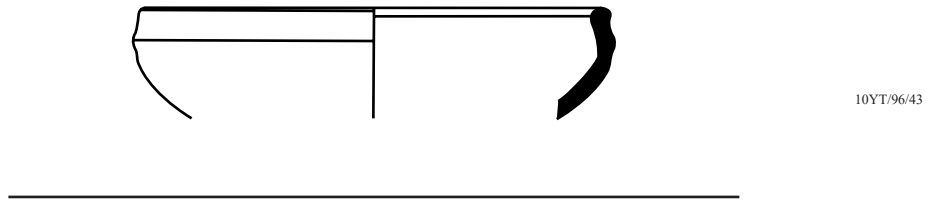
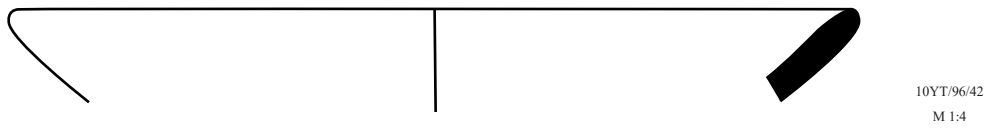
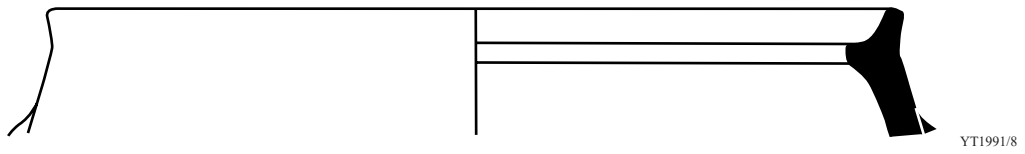
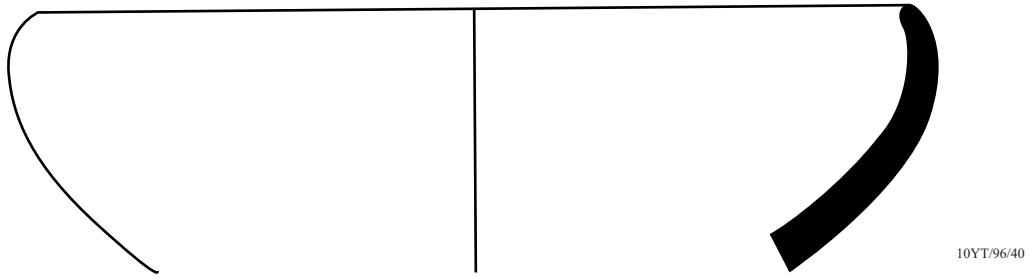

Yeni Yeldeğirmen-tepe - Survey Shallow bowl 4, Shallow bowl 5, Shallow bowl 7, Shallow bowl 12, Deep bowl 4, Narrow-mouthed jar 2 (M 1:2)

Figure 55

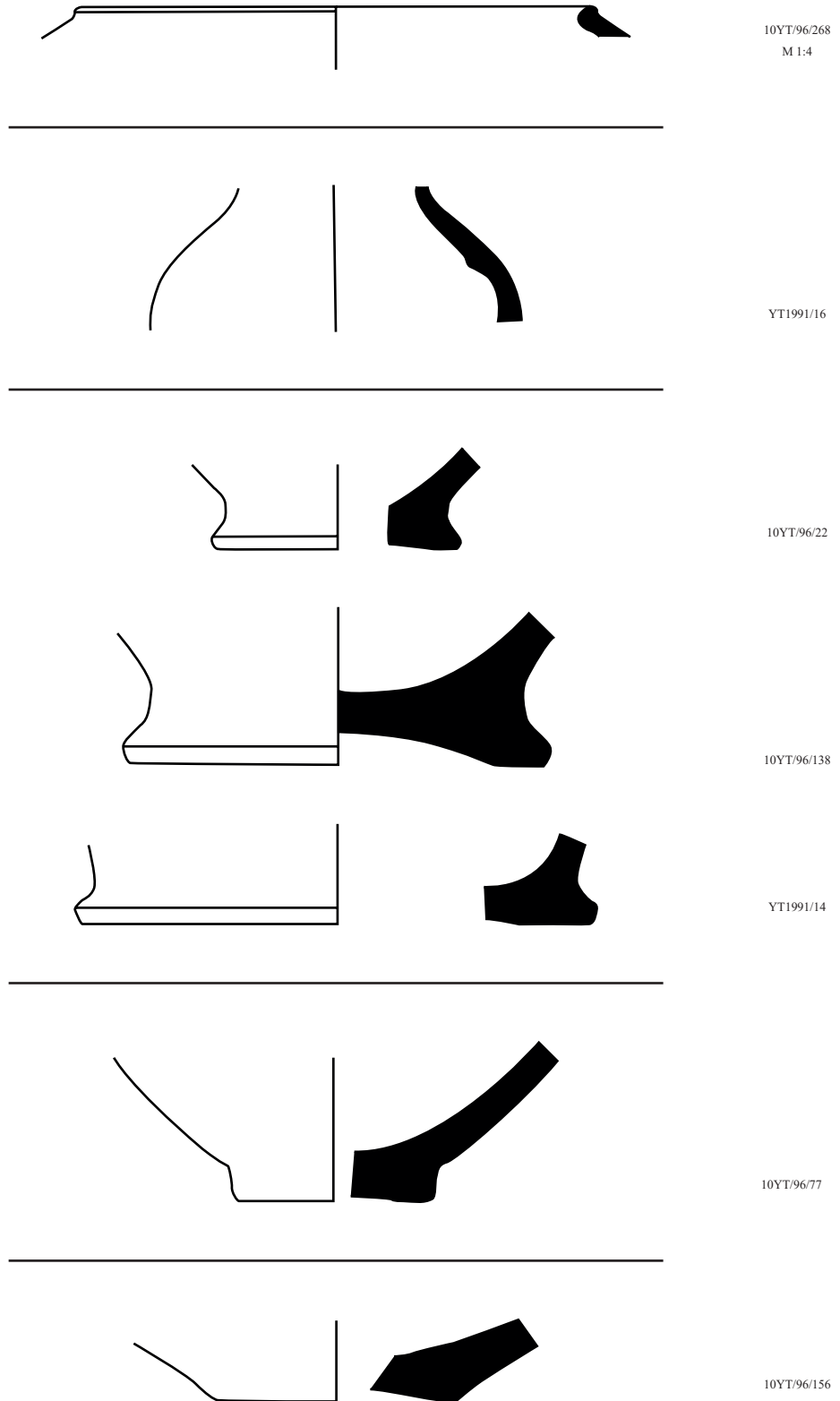



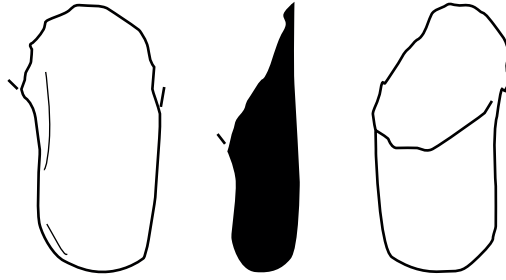

10YT/96/72

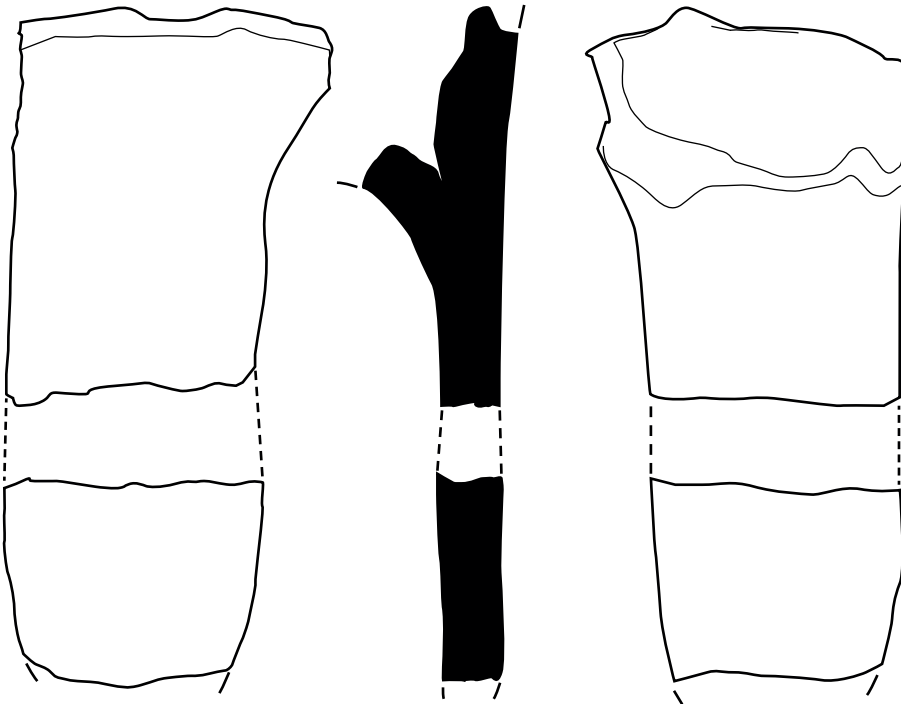

YT1991/6+7

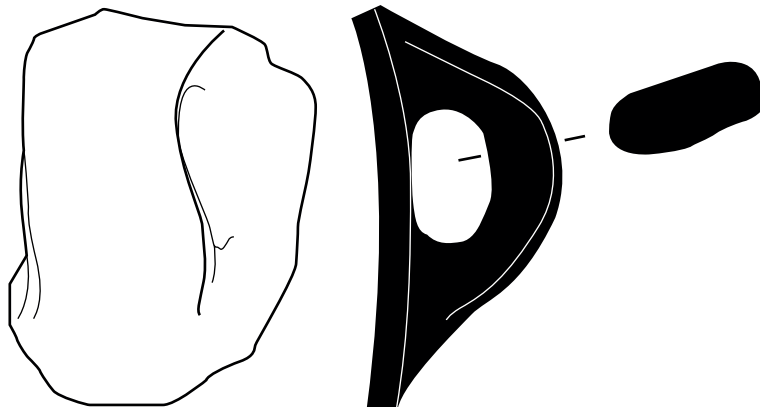

10YT/96/217

Yeni Yeldeğirmen-tepe - Survey Foot 1, Handle 1 (M 1:2)

Figure 57

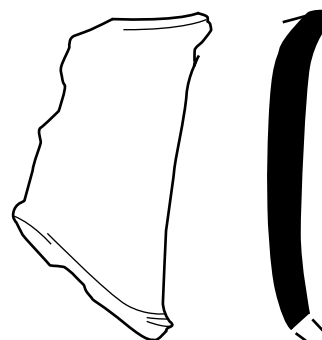
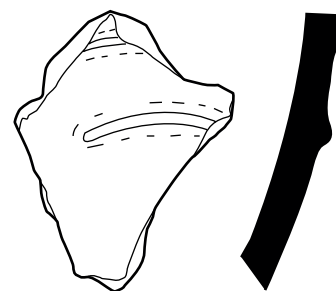
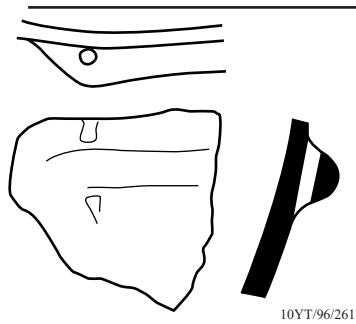
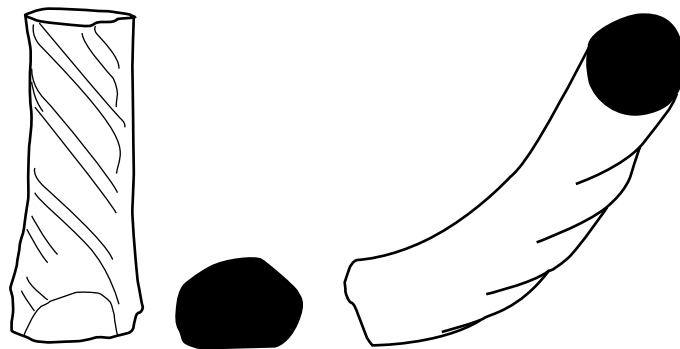
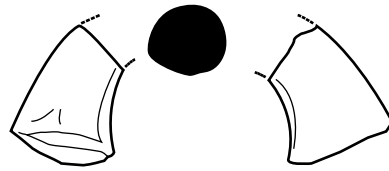
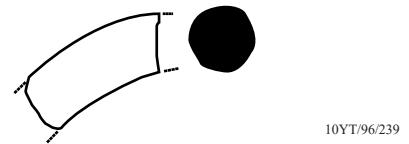
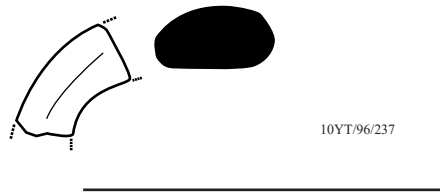
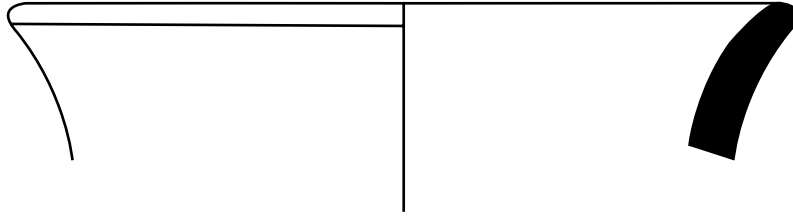

Figure 58



10YT/96/31



10YT/96/36

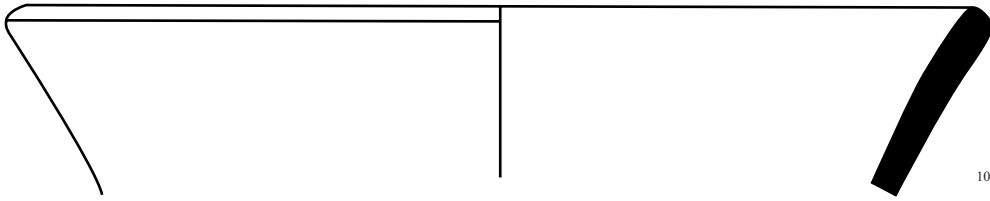

10YT/96/172



10YT/96/33

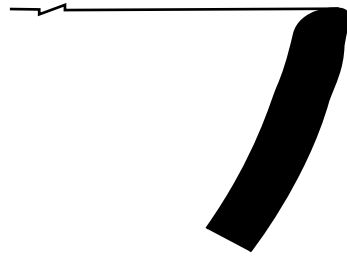

10YT/96/39

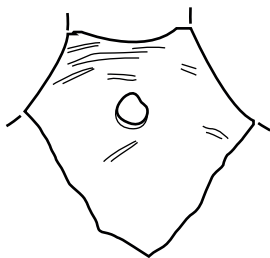

10YT/96/5

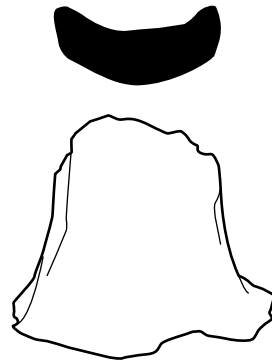
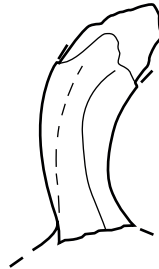

YT1991/13

Figure 59

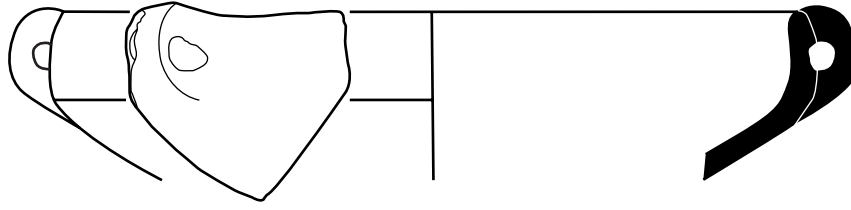

35HT/96/Z199  
Çizim 35

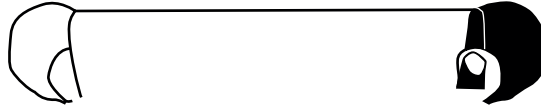

35HT/96/A524  
Çizim 47

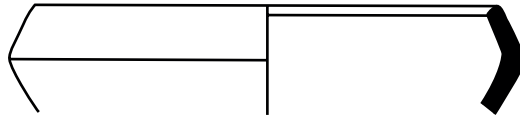

35HT/96/212  
Çizim 136



35HT/96/Z154  
Çizim 6

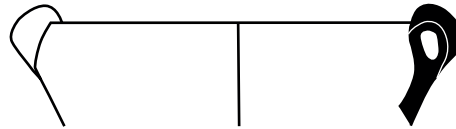

35HT/96/Z709  
Çizim 52

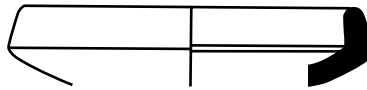

35HT/96/Z469  
Çizim 85

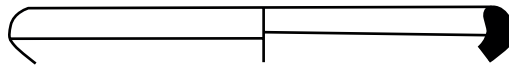

35HT/96/Z425  
Çizim 86

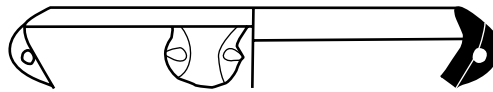

35HT/96/Film 33  
Çizim 111

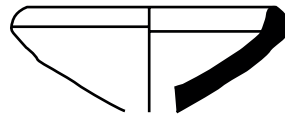

35HT/96/A319  
Çizim 124

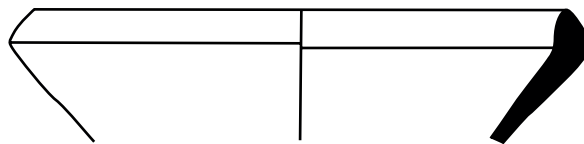

35HT/96/143  
Çizim 128

Hüücektepe - Survey Shallow bowl 1a, Shallow bowl 1b (M 1:2)

Figure 60

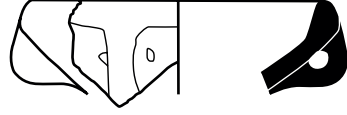

35HT/96/330  
Çizim 139

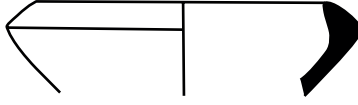

35HT/96/883  
Çizim 140

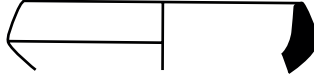

35HT/96/889  
Çizim 141

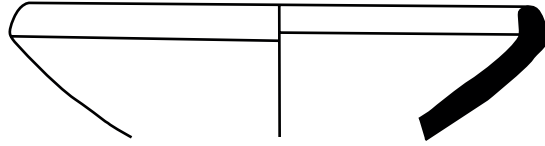

35HT/96/Z615  
Çizim 166

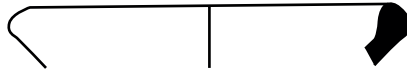

35HT/96/Z118  
Çizim 194



35HT/96/A937  
Çizim 16

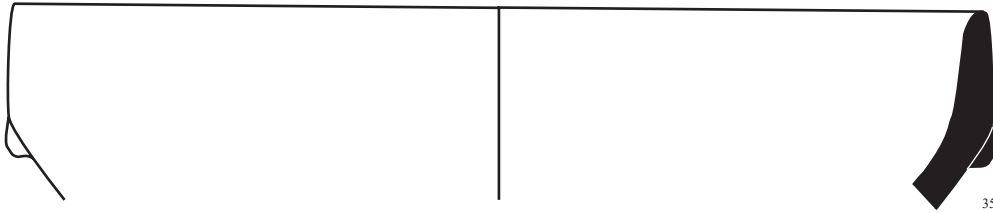

35HT/96/A591  
Çizim 69

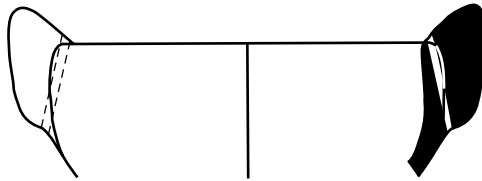

35HT/96/A368  
Çizim 113

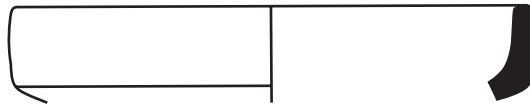

35HT/96/149  
Çizim 126



35HT/96/139  
Çizim 127

Hüyüktepe - Survey Shallow bowl 1b, Shallow bowl 2 (M 1:2)

Figure 61

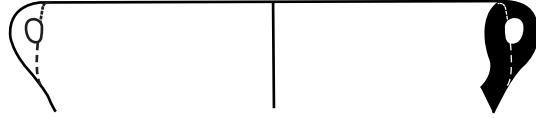

35HT/96/Y598  
Çizim 173

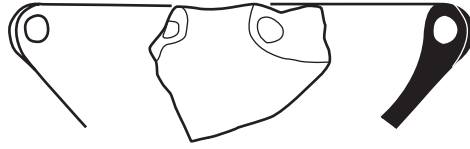

35HT/96/Film 31  
Çizim 2



35HT/96/Film 31  
Çizim 3

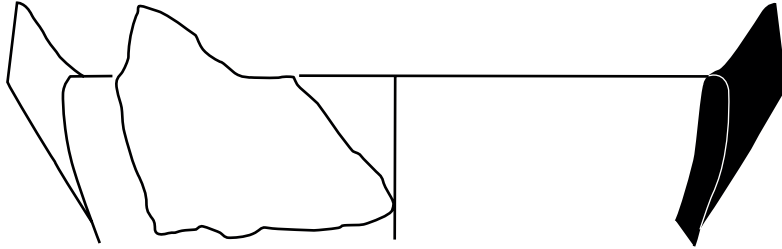

35HT/96/X406  
Çizim 132

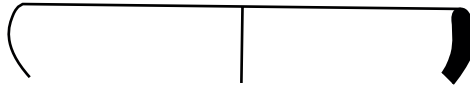

35HT/96/884  
Çizim 142



35HT/96/Film 31  
Çizim 4

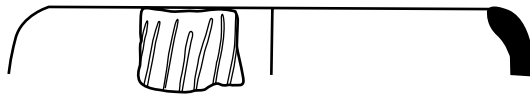

35HT/96/Film 30  
Çizim 21

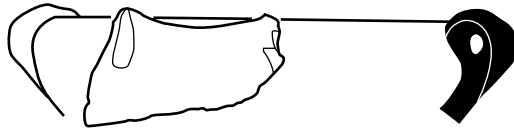

35HT/96/Film 31 (Top left)  
Çizim 48



35HT/96/Film 31  
Çizim 45

Hüyüktepe - Survey Shallow bowl 2, Shallow bowl 3, Shallow bowl 4 (M 1:2)

Figure 62

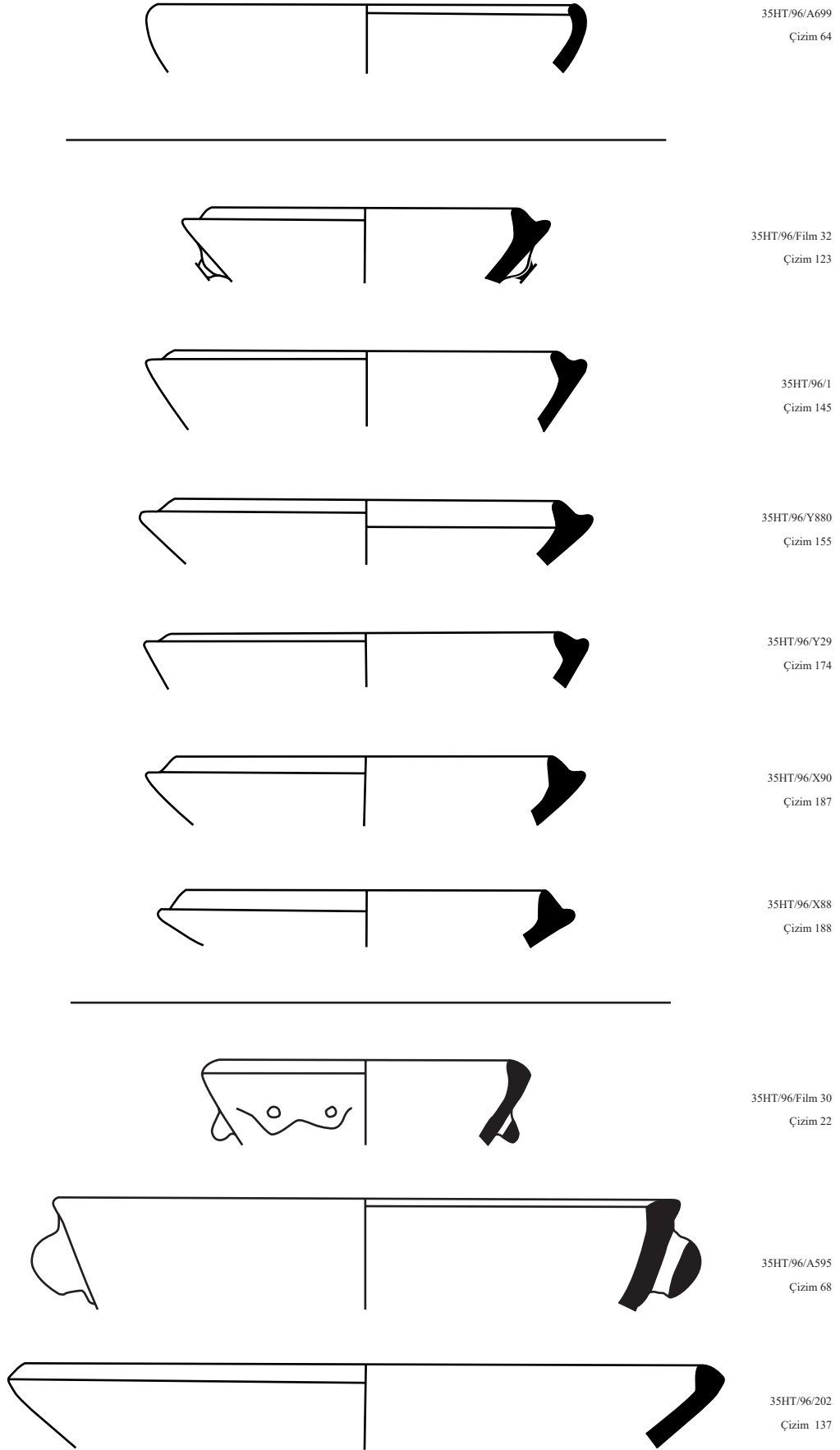

Hüyüktepe - Survey Shallow bowl 4, Shallow bowl 5, Shallow bowl 6a (M 1:2)

Figure 63



35HT/96/A925  
Çizim 17

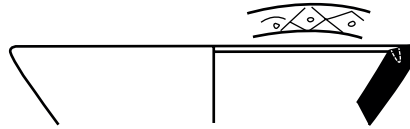

35HT/96/Y416  
Çizim 131

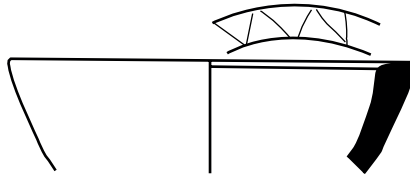

35HT/96/Y959  
Çizim 144

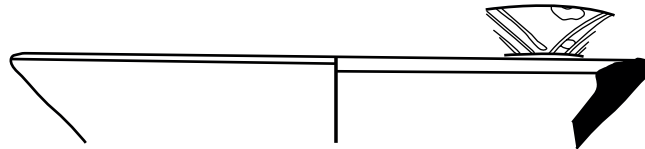

35HT/96/419  
Çizim 165

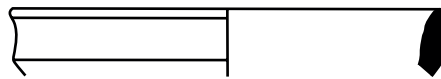

35HT/96/Z791  
Çizim 105

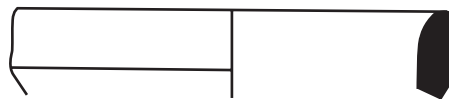

35HT/96/Z793  
Çizim 106



35HT/96/Film 30  
Çizim 112

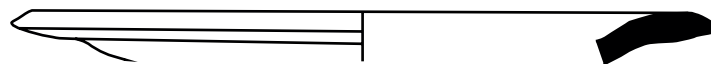

35HT/96/593  
Çizim 193

Hüyüektepe - Survey Shallow bowl 7, Shallow bowl 9A, Shallow bowl 12, Special shape 2, Shallow bowl 13?  
(M 1:2)



Figure 64

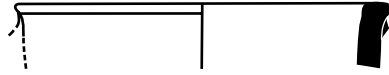

35HT/96/Z756  
Çizim 95

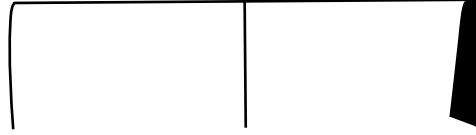

35HT/96/Z796  
Çizim 108

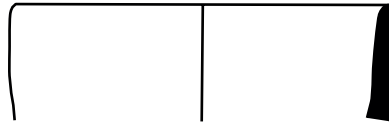

35HT/96/Z801  
Çizim 109

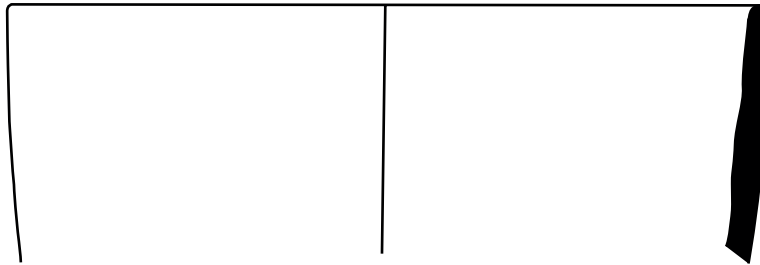

35HT/96/592  
Çizim 192

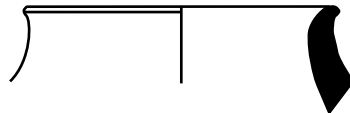

35HT/96/Y40  
Çizim 175

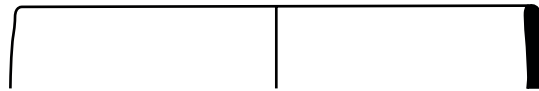

35HT/96/Z806  
Çizim 107



35HT/96/Z442  
Çizim 80

Hüyüektepe - Survey Deep bowl 1, Deep bowl 2, Narrow-mouthed jar 2, Narrow-mouthed jar 3, Neck-jar 3  
(M 1:2)

Figure 65

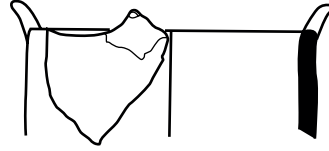

35HT/96/56  
Çizim 159

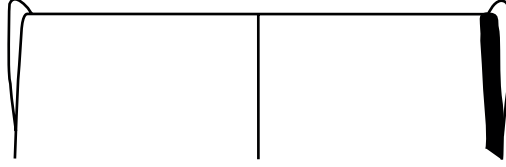

35HT/96/Y228  
Çizim 163

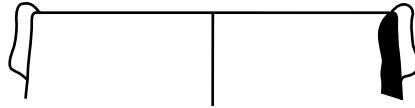

35HT/96/Y230  
Çizim 164

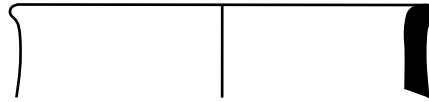

35HT/96/Y903  
Çizim 156



35HT/96/A556  
Çizim 58

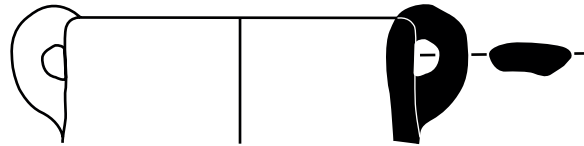

35HT/96/Y858  
Çizim 157

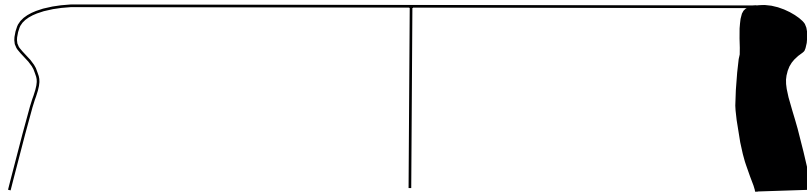

35HT/96/Y2  
Çizim 176

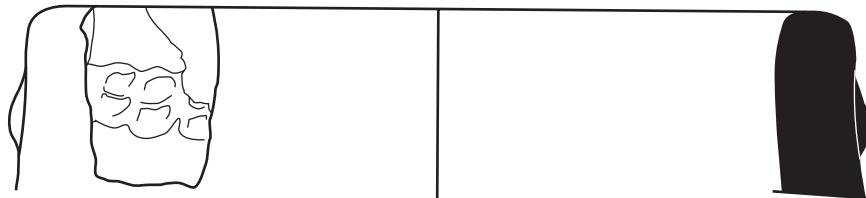

35HT/96/Y96?  
Çizim 143

Figure 66

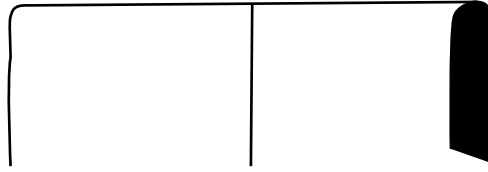

35HT/96/Z752  
Çizim 94

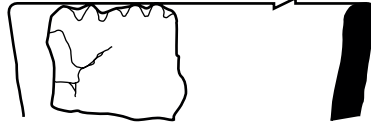

35HT/96/Film 19  
Çizim 121

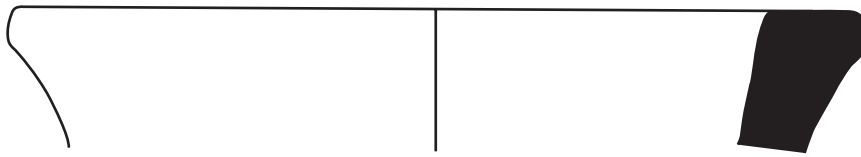

35HT/96/A717  
Çizim 33

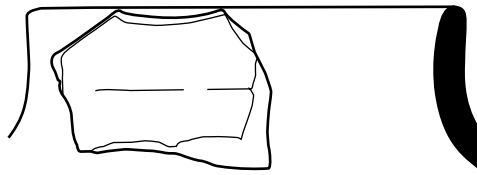

35HT/96/Z301  
Çizim 153

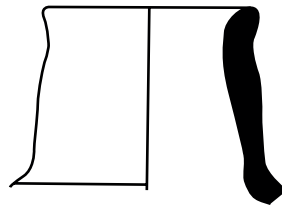

35HT/96/Film 31  
Çizim 103



35HT/96/Z632  
Çizim 169

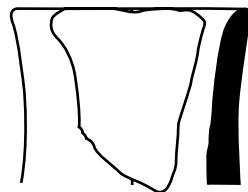

35HT/96/A207  
Çizim 62

Hüyüektepe - Survey Jar 4 , Jar/Cheesebowl?, Jar/Pithos?, Amphora 2, Amphora/Jug?, Jug 0, Jug 1 (M 1:2)

Figure 67

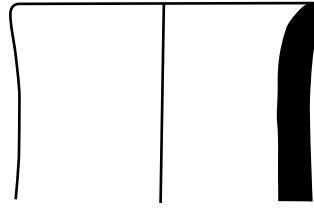

35HT/96/Y66  
Çizim 183

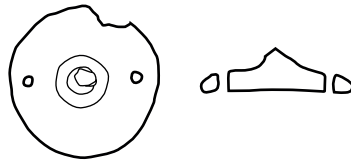

35HT/96/Film 31  
Çizim 1

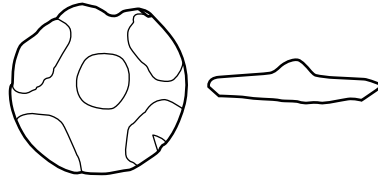

35HT/96/Film 31  
Çizim 70



35HT/96/X271  
Çizim 181



35HT/96/Y89  
Çizim 10

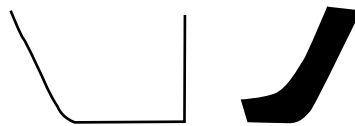

35HT/96/Z764  
Çizim 92

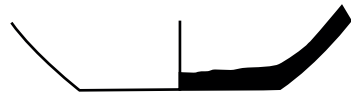

35HT/96/102  
Çizim 125



35HT/96/Y12  
Çizim 9

Figure 68



35HT/96/X127  
Çizim 190



35HT/96/619  
Çizim 160

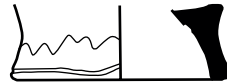

35HT/96/Z618  
Çizim 168

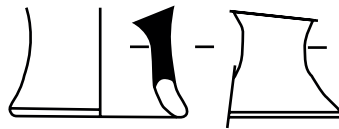

35HT/96/Y226  
Çizim 23



35HT/96/Y819a-b  
Çizim 182



35HT/96/Z745  
Çizim 93



35HT/96/Film 31  
Çizim 102

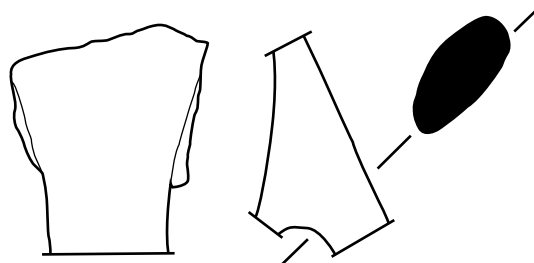

35HT/96/16  
Çizim 147

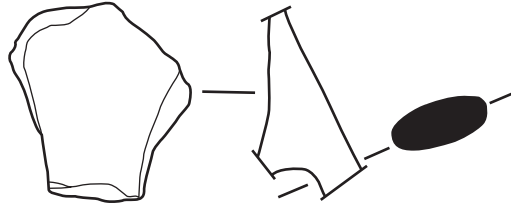

35HT/96/212  
Çizim 148

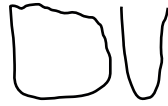

35HT/96/Z746  
Çizim 96



35HT/96/Z771  
Çizim 99

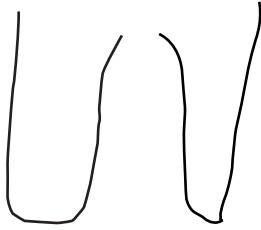

35HT/96/Z656  
Çizim 167

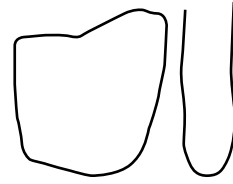

35HT/96/A424  
Çizim 185

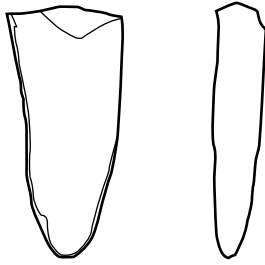

35HT/96/Z155  
Çizim 5

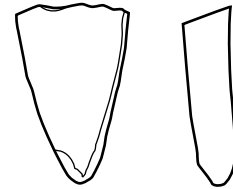

35HT/96/Z683  
Çizim 51

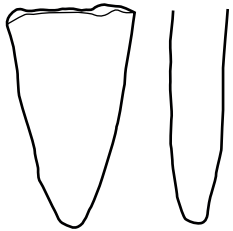

Çizim 74

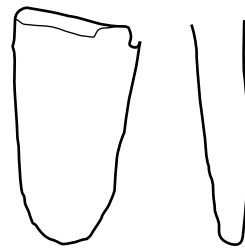

35HT/96/A125  
Çizim 76

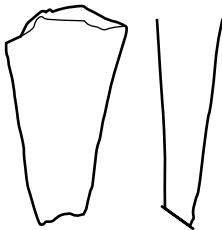

35HT/96/A122  
Çizim 77

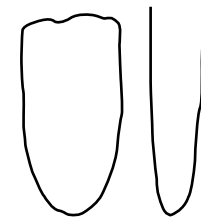

35HT/96/X138  
Çizim 186

Hüyüktepe - Survey Foot 0/Handle 1?, Foot 1, Foot 2 (M 1:2)

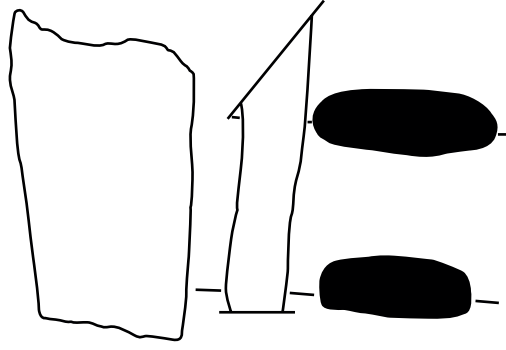

35HT/96/Y65  
Çizim 184

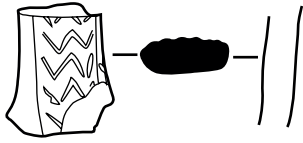

35HT/96/Y196  
Çizim 24

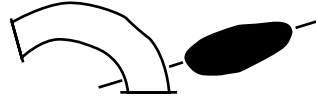

35HT/96/Z465  
Çizim 83

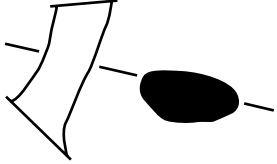

35HT/96/Z747  
Çizim 100

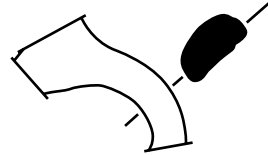

35HT/96/Z797  
Çizim 104

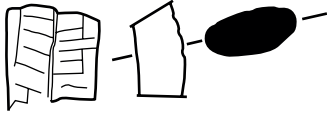

35HT/96/Film 33  
Çizim 110

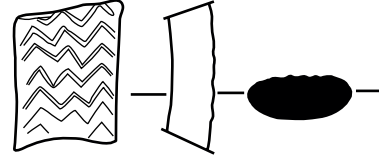

35HT/96/87  
Çizim 129



35HT/96/X103  
Çizim 189

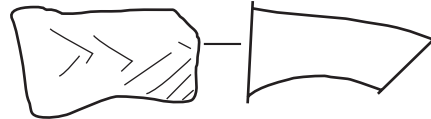

35HT/96/Y289  
Çizim 191



35HT/96/A861  
Çizim 34



35HT/96/Z909  
Çizim 41

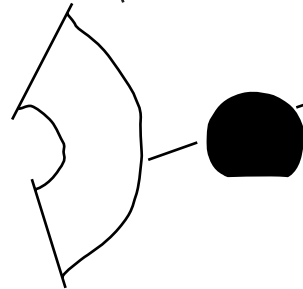

35HT/96/X81  
Çizim 171

Figure 71

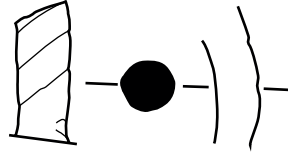

35HT/96/201  
Çizim 135

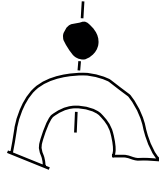

35HT/96/749  
Çizim 151



35HT/96/Z308 Çizim 152

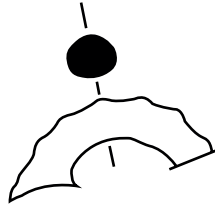

35HT/96/742+745  
Çizim 150



35HT/96/Z782  
Çizim 97

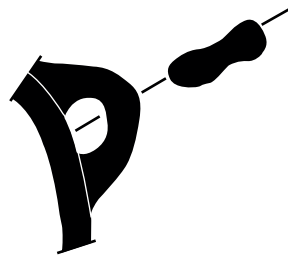

35HT/96/X701 Çizim 134

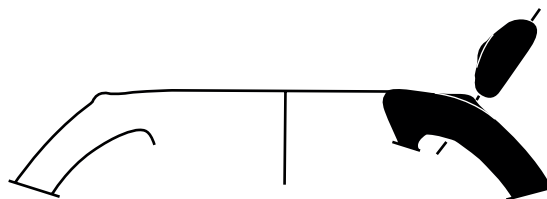

35HT/96/X312 Çizim 158



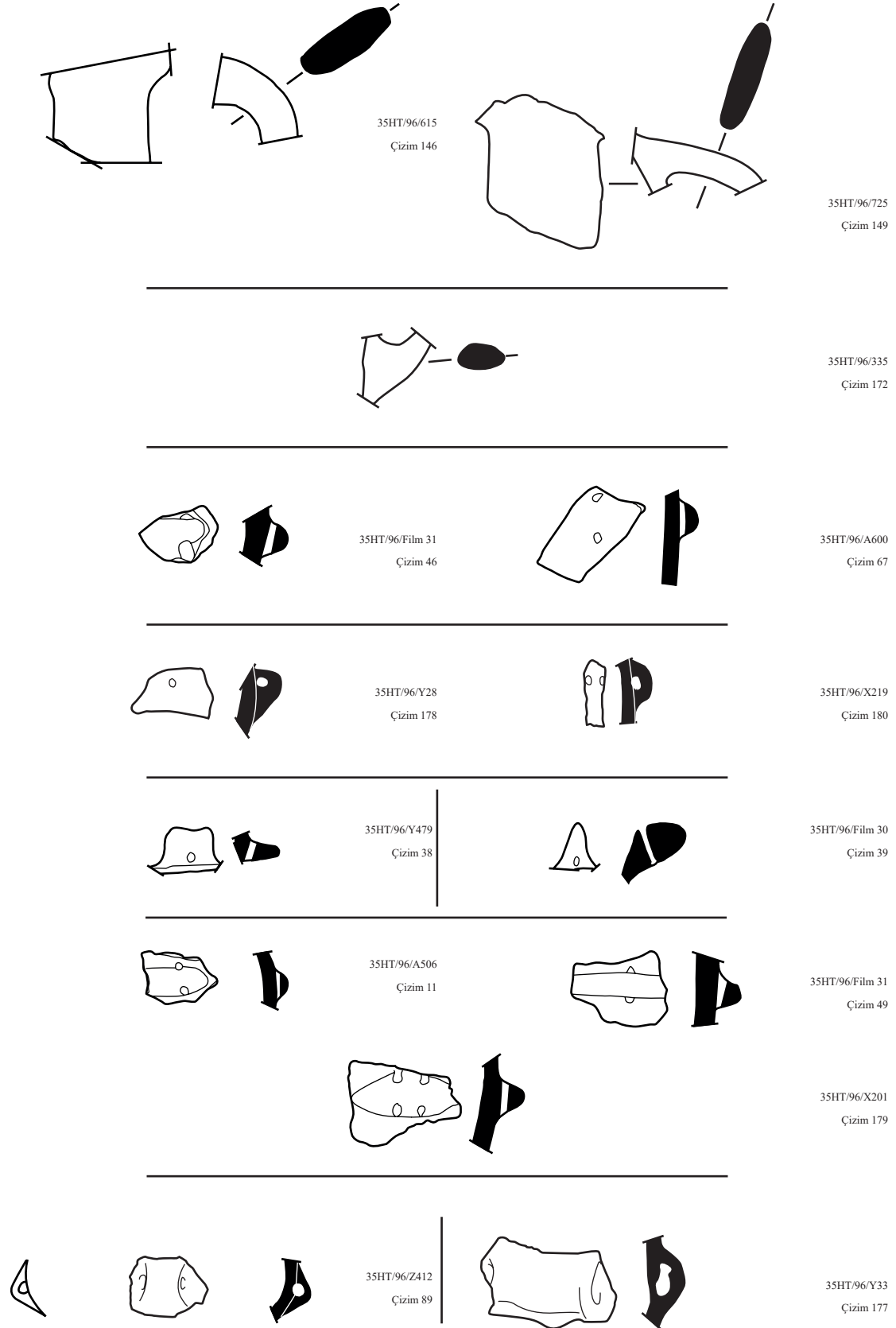

Hüyüktepe - Survey Handle 12, Handle 14, Knob 1, Knob 2, Knob handle 5, Knob handle 6, Bar handle 2, Lug 3A, Lug 3B (M 1:2)

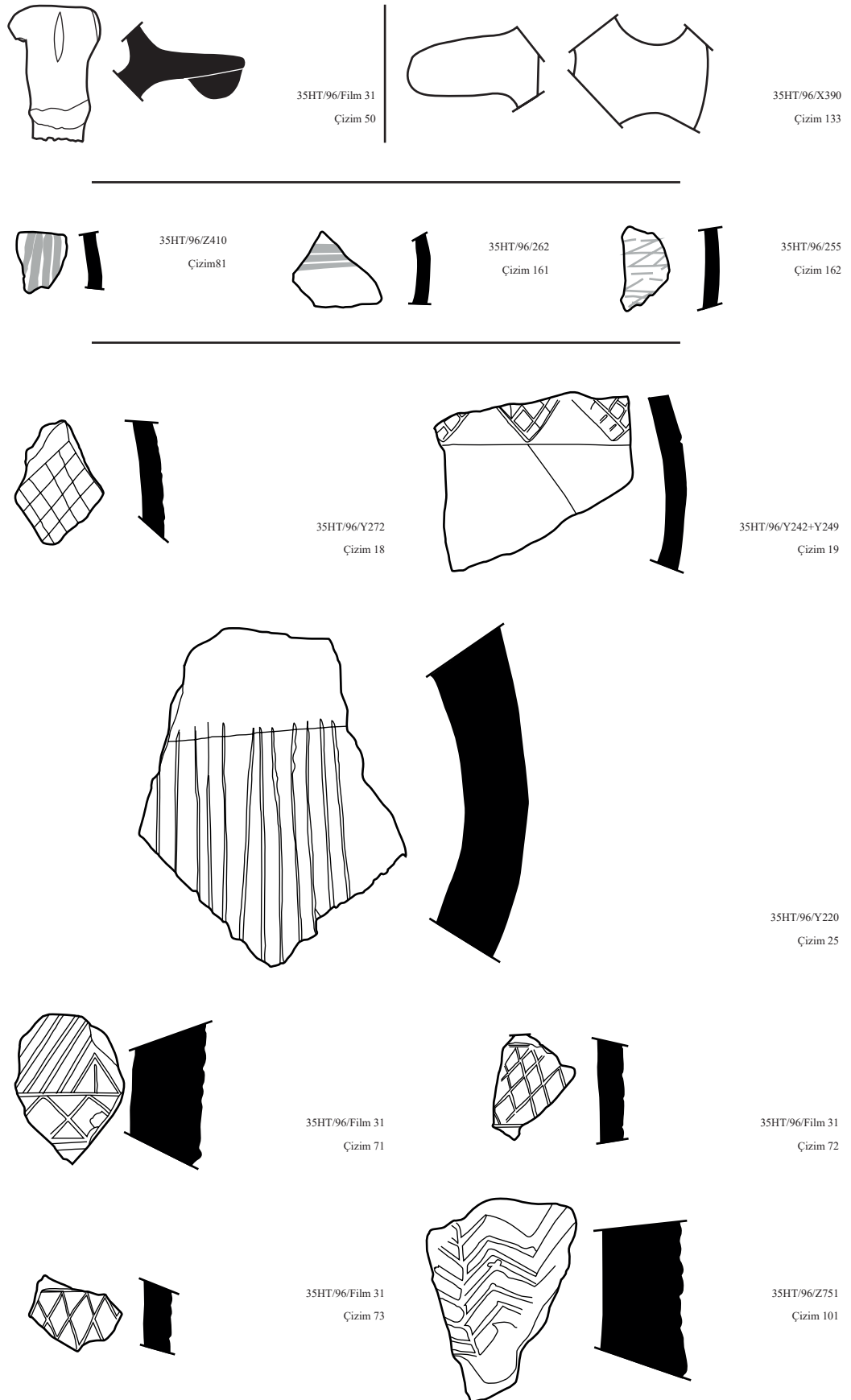

Hüyüektepe - Survey Ledge handle 7, Ledge handle 8, Characteristic wall fragment 1, Characteristic wall fragment 2a (M 1:2)

Figure 74

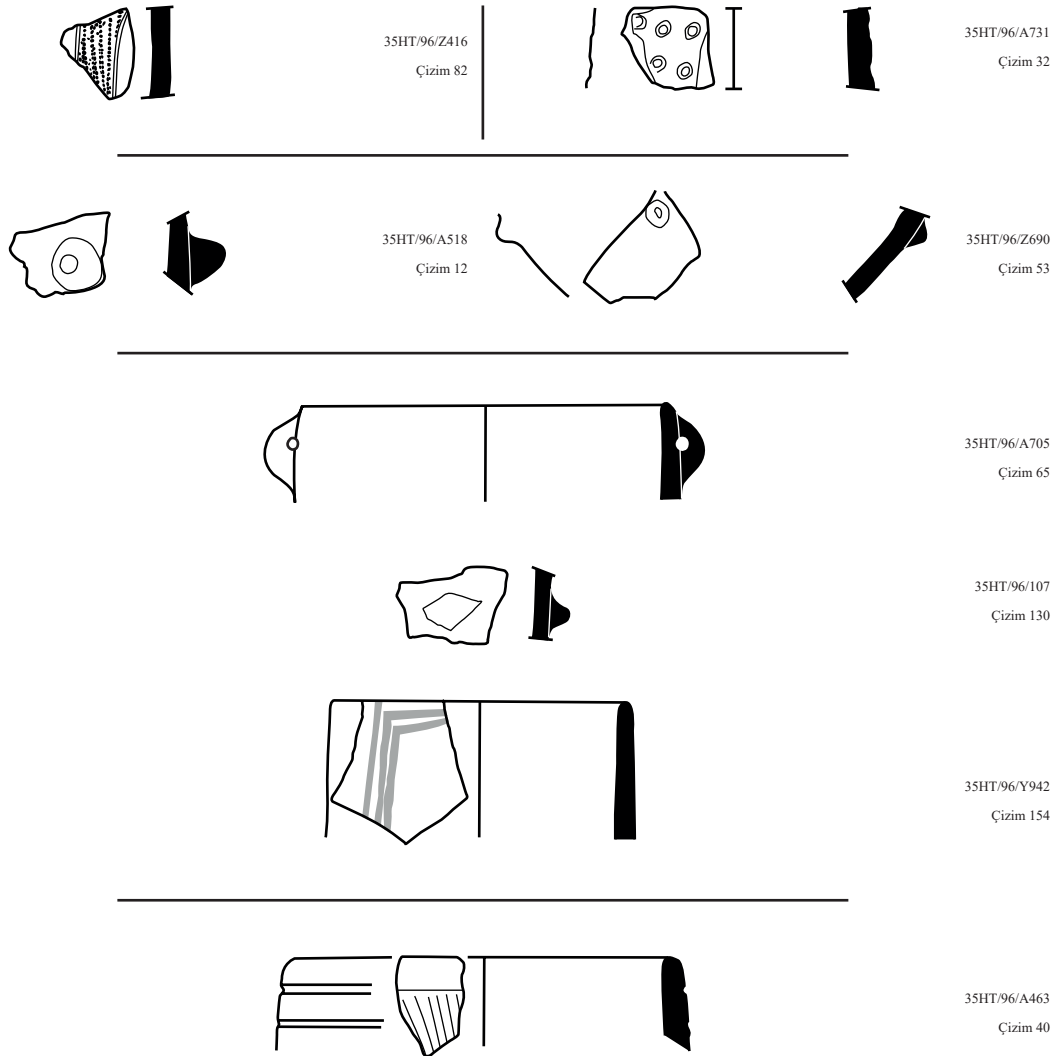

**Hüyücektepe - Survey** Characteristic wall fragment 2e, Characteristic wall fragment 4,  
Characteristic wall fragment 7, Unclear shapes, Roman Period ? (M 1:2)

Figure 75

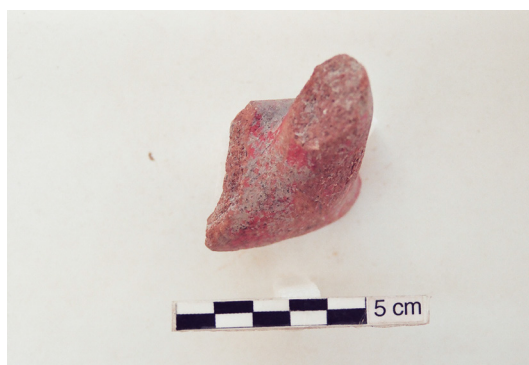
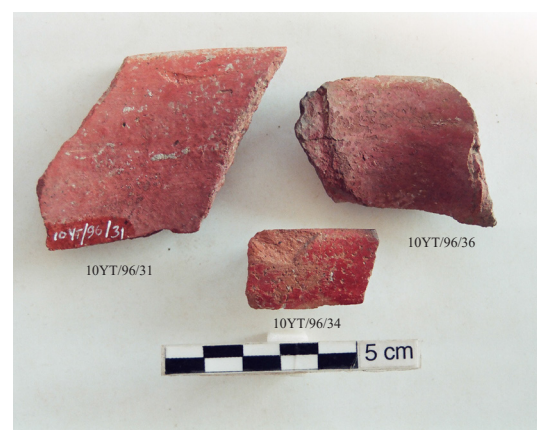
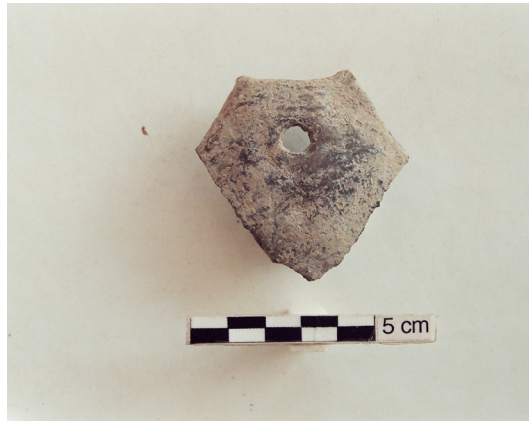

Yeni Yeldeğirmen-tepe - Survey (M 1:2)



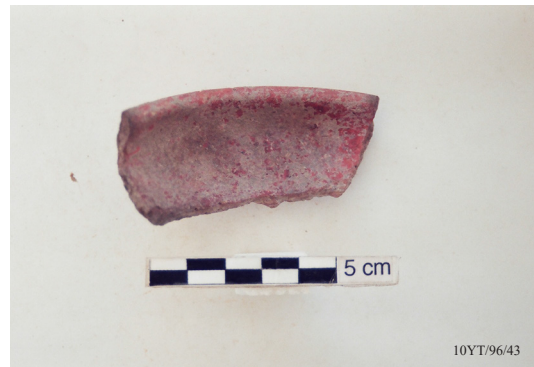
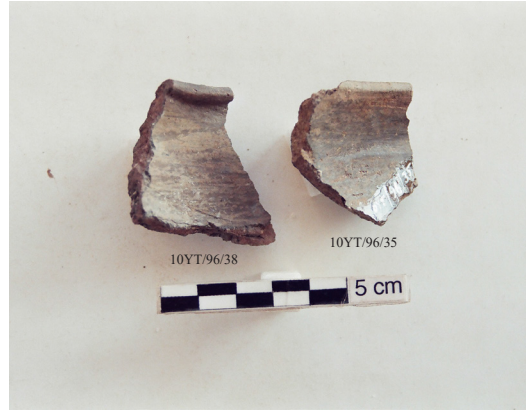

Yeni Yeldeğirmentepe - Survey (M 1:2)

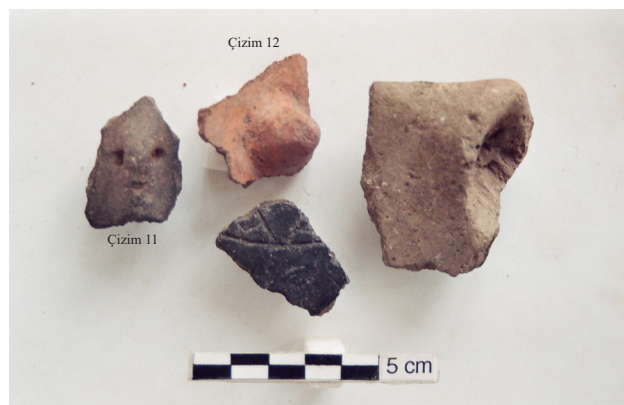

Hüyüektepe - Survey (M 1:2)











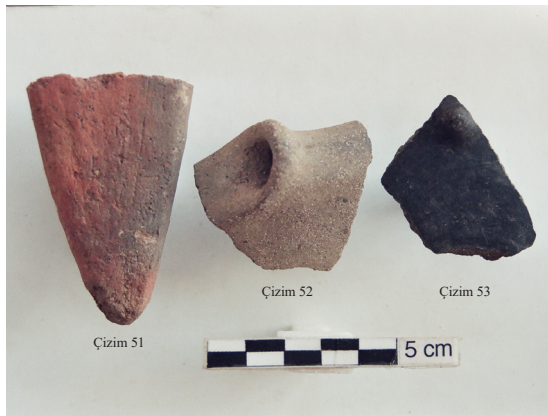
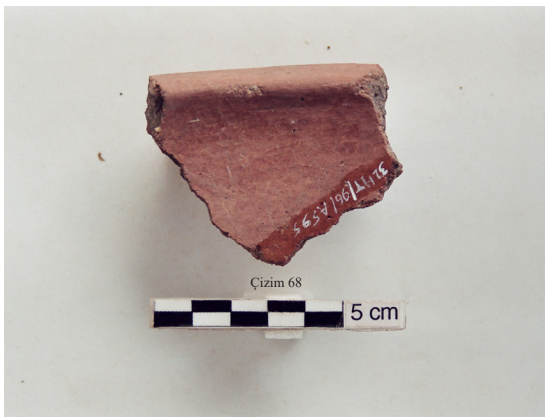
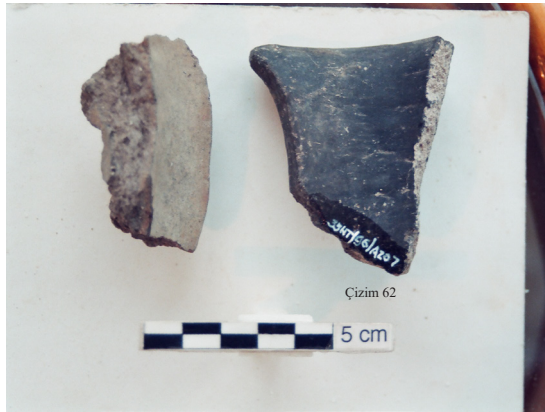



Figure 81







Hüyüektepe - Survey (M 1:2)





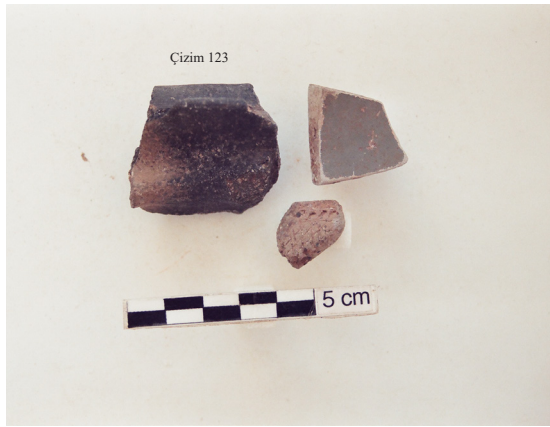

Hüyücektepe - Survey (M 1:2)





Hüyüektepe - Survey (M 1:2)



Hüyüektepe - Survey (M 1:2)





Hüyüektepe - Survey (M 1:2)





Hüyüektepe - Survey (M 1:2)













Hüyüektepe - Survey (M 1:2)